

METEOR HANDHELD CENTRIFUGE OPERATORS MANUAL

CE

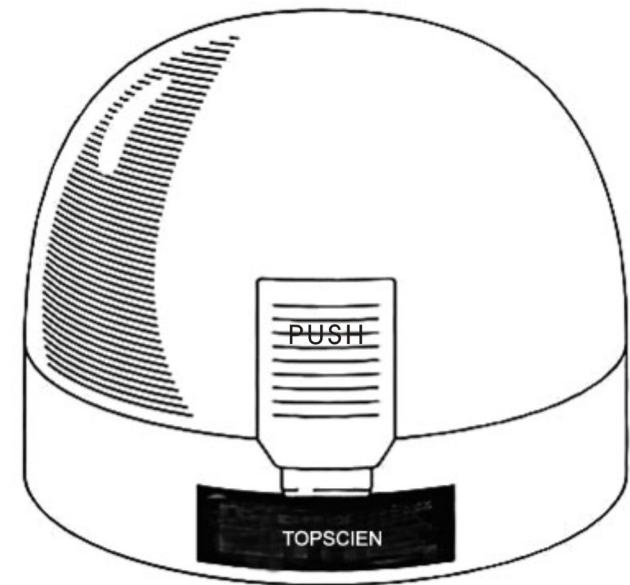

TOPSCIEN®

Topscien Instrument (Ningbo) Co.,LTD

808 Room ,8/F , JvHong Commercial Mansion,

South business district,Ningbo ,China

Tel:+86-4001 1234 560 +86 574 88455466

Fex:+86 574 88459578

www.topscien.com

TOPSCIEN®
www.topscien.com

Topscien Instrument Co.,LTD is in possession of a registered and certified quality management system which includes the development ,production, and sales of high quality centrifuge instrument

CONTENTS

1. PREFACE	1
2. GENERAL PRECAUTIONS	2 - 5
3. PARTS IDENTIFICATION	6
4. INSTALLATION	7-8
[1] Moving the Centrifuge	7
[2] Installation Site.....	7
[3] Power Outlet	8
5. OPERATION	9-14
[1] To open the lid	9
[2] To turn the power on	10
[3] To plug the centrifuge	10
[4] To mount the rotor	10
[5] To load tubes on the rotor	11-13
[6] To close the lid and start the centrifuge	14
[7] To stop the centrifuge	14
[8] To turn the power off	14
[9] To dismount the rotor	14
[10] To unplug the power cord.....	14
6. ROUTINE MAINTENANCE.....	15-16
[1] To inspect and clean the rotor.....	16
[2] To inspect the motor shaft boss	16
[3] To inspect and clean the chamber	16
[4] To inspect the power plug and the outlet	16
[5] To inspect the lid and lid lock	16
[6] To clean the body.....	16
7. TROUBLESHOOTING.....	17
8. AFTER SERVICE.....	18
9. SPECIFICATIONS	19

9. SPECIFICATIONS

Model	Meteor 7.2k	Meteor 4k-7.2k	Meteor 10k	Meteor 4k-7.2k-10k	Meteor 12k
Speed (±5)	7,200rpm	4,000rpm-7,200rpm	10000rpm	4krpm-7.2krpm-10krpm	12000rpm
Rotor	8011154-1/ 8011154-2				8011154-5
RFC		810~3260xg	6652xg	810~6652xg	8550xg
The Max Capacity	1.5ml(2)mlx8				D1.5MMX40MM
Power	AC85V-264V50/60HZ				
Outside measurement					
Material	Cover	PC (UL94V-0)			
	Main frame	ABS (UL94V-0)			
	Absorber	NBR			
	Rotor	ABS (UL94V-0)			
	Adapter	PP (UL94V-0)			
Speed control	Automatic/Constant speed				
Driving system	Direct Drive/Vibration				
Brake system	Dynamic Braking				
Acceleration time	Attain the 90% rated speed within 5 seconds				
Deceleration time	The cover closed: within 15 seconds				
	The cover opened: within 3 seconds				

[7]. TROUBLESHOOTING

Use the following troubleshooting procedures to resolve problems with the centrifuge. If the centrifuge still will not run properly, call for service.

NOTE : Clean and decontaminate your centrifuge before you ship it back for service or before you allow a service technician to repair it.

Sympton	Probable Cause	Sympton
The centrifuge won't run	The power cord is unplugged	Plug the power cord in
	The fuse is blown	Call for service
	Motor carbon brushes lost conductivity because of a long term inventory	Turn the rotor five or six times gently by hand.
	Foreign articles wind around the rotor shaft.	Remove the foreign articles after unplugging the centrifuge.
	The motor is near the end of its expected life	Call for service.
Abnormal noise The centrifuge vibrates abnormally.	Imbalanced loads	Balance the load properly.
	Foreign articles is sticking on the rotor or chamber.	Remove the foreign articles after unplugging the centrifuge.
	Defective motor	Call for service.
The rotor won't be installed properly.	The rotor is seated upside down.	Seat the rotor properly.
	Damaged or deformed rotor or motor shaft boss.	Call for service.

[8]. AFTET SERVICE

To replace the motor

The centrifuge uses carbon brushes in the motor. It is necessary to replace the whole motor when carbon brushes are worn. Call for service, Please note that the motor is out of the warrant.

The expected life for motor is several years with normal use or several months when the centrifuge is used very often.

For Assistance or Service Contact:

TEL:0086-4001 1234 560 www.topscien.com

1. PREFACE

This centrifuge is electrically powered and spins rotors at high speeds.

Therefore, certain electrical and mechanical hazards are inherent with its use.

Improper installation or misuse will increase your chance of being injured or killed.

This Operators Manual contains specific instructions pertaining to the proper installation, Use and maintenance of the centrifuge.

Certain terms and symbols are used throughout this manual to emphasize hazards.

We distinguish between the terms and symbols as follows:

Warning

Means

means that misuse may cause death or serious injury to the operator or persons nearby.

Caution

Means

means that misuse may cause injury to persons or damage to the centrifuge and surrounding property.

Pay close attention to the information associated with these terms and symbols.

Warning

Be sure to seat and strict the rotor properly before operation

Improperly installed rotor may come off the motor shaft and may injure someone.

Improperly roto may come off the motor shaft and may injure someone.

2.GENERAL PRECAUTIONS

The followings are general warnings and cautions concerning the use of the centrifuge. Observe these precautions strictly.

Warning

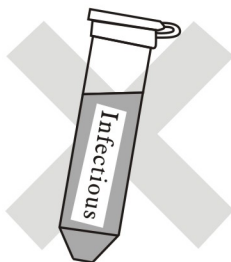

Infectious Sample Aerosols

This centrifuge is not equipped with a back-up isolation-system to contain aerosols in the event a tube leaks or breaks during a run.

If you suspect that exposure to aerosols from samples you are handling put them in this centrifuge.



NEVER centrifuge explosive or flammable substances.

Explosive or flammable items that ignite during a run will cause the centrifuge to explode. This centrifuge does not provide adequate protection from explosions or fires originating in the chamber. Do not overfill tubes.

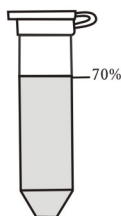

Tubes more than 70 percent full will cause the sample leaking during the run. This will expose you and the centrifuge to sample aerosols that may make you ill or may damage the centrifuge.

Warning

NEVER attempt to clean the centrifuge while it is plugged in or when the power is on. You may get shocked or you may be injured by moving parts.

[1] To inspect and clean the rotor

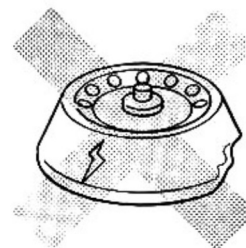

Visually inspect rotor for damage such as dents or chips from being dropped. If the rotor is damaged, do not use the centrifuge and call for service.

Wipe the rotor with a soft cloth moistened with a neutral detergent with extreme care and remove the detergent with a clean damp cloth.

[2] To inspect the motor shaft boss

Visually inspect the rotor for damage or deformation.

Stop the operation and call for service when the rotor is damaged or deformed.

[3] To inspect and clean the chamber

Inspect the chamber for loose debris and excess water and remove as necessary.

Wipe the chamber with a soft cloth moistened with a neutral detergent with extreme care and remove the detergent with a clean damp cloth.

[4] To inspect the power plug and the outlet

Inspect the power plug and outlet for a loose connection and dust.

[5] To inspect the lid and lid lock

Inspect the lid is able to open and close smoothly.

Inspect the lid is locked when pressing down.

[6] To clean the body

Wipe the body with a soft cloth moistened with a neutral detergent with extreme care and remove the detergent with a clean damp cloth.

6. ROUTINE MAINTENANCE

Warning

Never attempt to clean the centrifuge while it is plugged in or when the power is on. If the device or accessories are contaminated by a pathogenic, toxic, or radioactive substance etc., it is the user's responsibility to carry out appropriate decontamination while referring to the WHO Laboratory Biosafety Manual, 2nd revised edition, etc. When cleaning and decontamination other than mentioned in this chapter are required, contact our company to check whether or not they are likely to damage the device. If you are planning to return the device or accessories to our company or are requesting repair, you must contact our company before sending these items to us. In some cases a certificate of implementation of cleaning and decontamination may be required before the items can be sent to us.

Check and clean your centrifuge at regular intervals or immediately after spills occur to prevent premature wear and safety hazards.

Warning



Use caps for tubes. Tubes without caps will cause the sample leaking during the run. This will expose you and the centrifuge to sample aerosols that may make you ill or may damage the centrifuge.

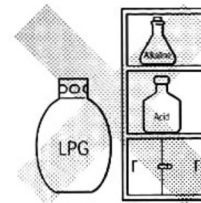

Do not install the centrifuge near sources of water or gas or near chemical storage areas. Installation near gas or water generating facing may result in fire, explosion or other damage to the equipment or facility.

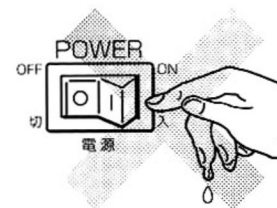

Do not touch the power switch with wet hands. You may sustain a serious or deadly electrical shock.

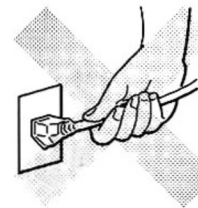

Do not unplug the centrifuge with pulling the power cord. Stress to the cord may cause a loose connection in the plug and result in a fire.

Warning

Don not touch the power plug with wet hands.
You may sustan a serious or deadly electrical shock.

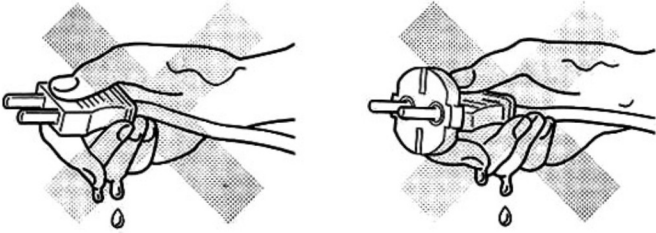

Do not modify the centrifuge.
Modification to the centrifuge may cause a serious malfunction, damage the centrifuge or cause in jury to some one.

Unplug the power cord while not using.
Stress to the cord may cause a loose connection in the plug and result in a fire.
Do not use accessories or parts othse specified by the manufacturers.
Substitued accessories or parts that do not meet the manufacturers performance specifications may cause serious damage to the centrifuge or injure someone.

[6]To close the lid and start the centrifuge

Close and firmly press down the lid until the lid locks into position. The rotor will begin spinning when the lid is completely closed.

[7]To stop the centrifuge

Push the stop lever, open the lid and remove the rubes after the rotor has stopped spinning.

[8]To turn the power off

Turn the power switch off.

[9]To dismount the rotor

Pinch the knob of rotor with fingers and pull out the rotor.

[10]To unplug the power cord

Unplug the power cord whild not using.

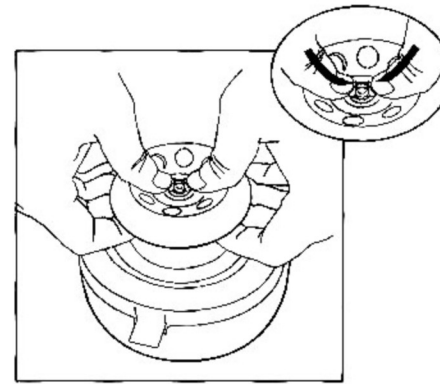

Warning

Do not pull out the rotor by force.
That may bend the motor shaft and damage the motor shaft boss.

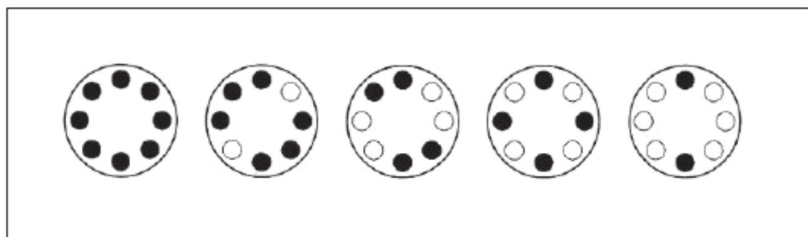

Tube - strips Rotor

Place all two lines tubes into the rotor.

Correct Tube Placement

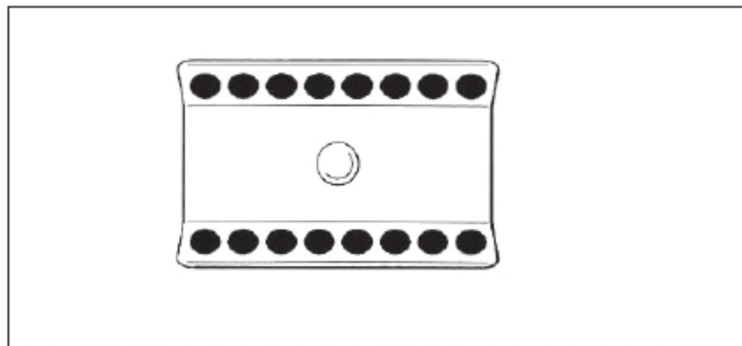

⚠ Warning

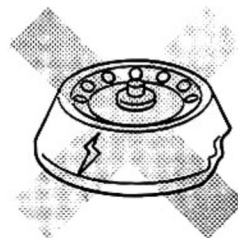

Do not use damaged or deformed rotors. Rotors with compromised structures are subject to sudden and severe imbalances that will damage the centrifuge and may injure someone.



Be sure to balance the load properly. Imbalance loads will significantly reduce the life of the motor and centrifuge. In severe cases, imbalances may damage the centrifuge and injure the operator.

Do not open the lid until rotor has stopped completely. Injury may occur from moving parts.

Do not replace the fuse other than those specified by the manufacturer. That will damage the centrifuge and may injure someone.

3. PARTS IDENTIFICATION

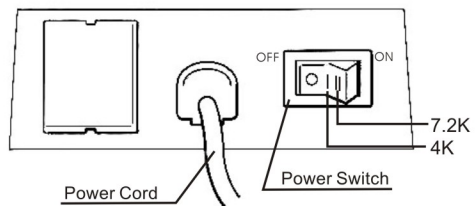
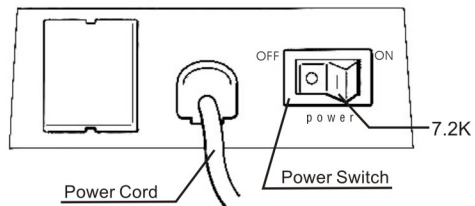
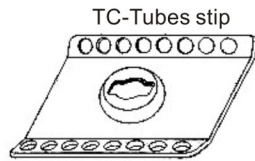
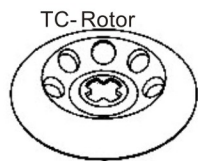
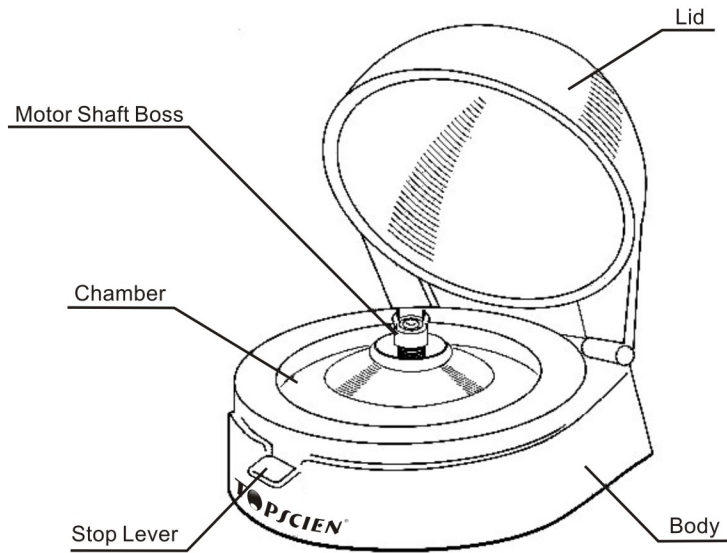

Warning

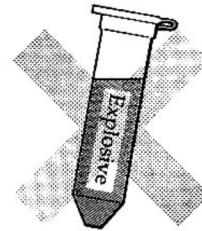

NEVER centrifuge explosive or flammable substances. Explosive or flammable items that ignite during a run will cause the centrifuge to explode. This centrifuge does not provide adequate protection from explosions or fires originating in the chamber.

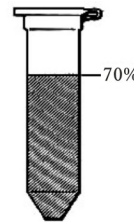

Do not overfill tubes. Tubes more than 70 percent full will leak during the run. This will expose you and the centrifuge to sample aerosols that may make you ill or may damage the centrifuge.

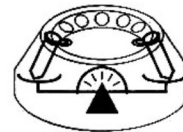

Be sure to balance the load properly. Imbalance loads will significantly reduce the life of the motor and centrifuge. In severe cases, imbalances may damage the centrifuge and injure the operator.



Use caps for tubes. Tubes without caps will leak during the run. This will expose you and the centrifuge to sample aerosols that may make you ill or may damage the centrifuge.

Place tubes symmetrical into the rotor. Imbalance load will significantly reduce the life of the motor and centrifuge. In severe case, imbalances may damage the centrifuge and injure the operator.

Microtubes Rotor

Place the eight, four or two microtube samples symmetrically in to the rotor.
Correct Tube Placement

[3] To open the lid

Press the stop lever down and open the lid.

[4] To mount the rotor

Mount a rotor on the motor shaft observing the shapes of motor shaft boss and the center hole of rotor .Push down the rotor until it clicks.

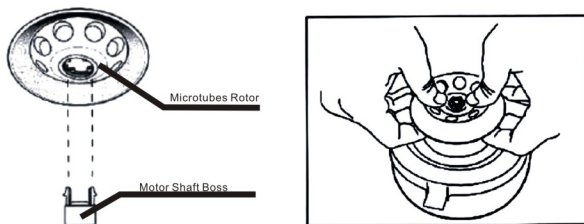

⚠ Warning

Be sure to seat and secure the rotor properly before operation.
Improperly installed rotor may come off the motor shaft and may injure someone.
Do not seat the rotor up side down.
Improperly rotor may come off the motor shaft and may injure some one.

[5] To load tubes on the roto

⚠ Warning



Infectious Sample Aerosols

This centrifuge is not equipped with a back-up isolation system to contain aerosols in the event a tube leaks or breaks during a run .

If you suspect that exposure to aerosols from samples you are handling could cause permanent or fatal illness , do not put them in this centrifuge .

⚠ Warning

Do not allow water or sample to drop or fall inside the centrifuge
This may cause an electrical short and may shock someone

ADJUSTABLE SPEED

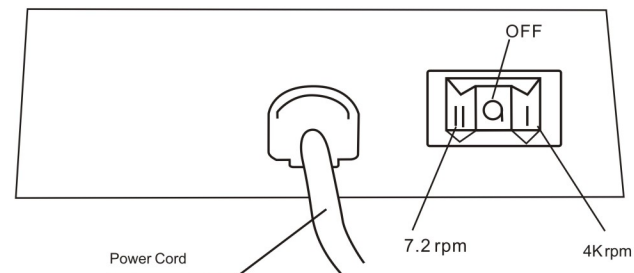

4. INSTALLATION

[1] Moving the Centrifuge

Caution

- Do not drop the centrifuge or bump into things when moving it.
- Do not move the centrifuge with pulling its power cord.
- Do not move the centrifuge with pulling its lid.

[2] Installation Site

Warning

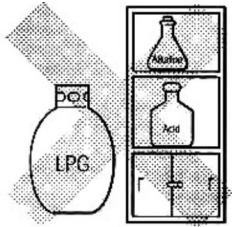

NEVER Install the centrifuge near chemical storage facilities or sites likely to generate flammable gases or fumes. That will damage the centrifuge and may result in a fire.

Do not leave the centrifuge in a cold room less than 5°C for extended period of time. That will damage the centrifuge and may result in a fire.

Caution

Install the centrifuge on a flat and level surface such as a solid surface bench top. Keep the centrifuge out of direct sunlight, dust and poorly ventilated areas. Required Environmentla Conditions : Room Temperature : 5° to 35°C !

Atmospheric Pressure : 70 to 106 k Pa
Relative Humidity : 30 to 85%

[3] Power Outlet

Caution

Connect the centrifuge to an outlet that is properly rated.

- AC 120V 80m A 50/60 Hz
- AC 230V 45m A 50/60 Hz

5. OPERATION

This section covers the following procedures:

- [1] To plug the centrifuge
- [2] To turn the power on
- [3] To open the lid
- [4] To mount the rotor
- [5] To load tubes on the rotor
- [6] To close the lid and start the centrifuge
- [7] To stop the centrifuge
- [8] To turn the power off
- [9] To dismantle the rotor
- [10] To unplug the power cord

[1] To plug the centrifuge

Warning

Do not touch the power plug with wet hands. You may sustain a serious or deadly electrical shock.

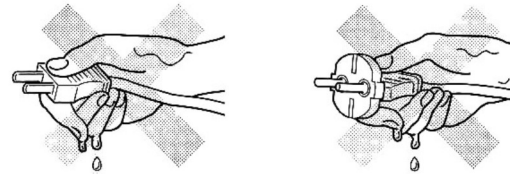

[2] To turn the power on

Warning

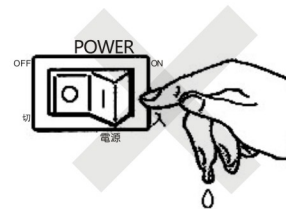

Do not touch the power switch with wet hands. You may sustain a serious or deadly electrical shock