

**AUTOCLAVES AUXILAB**  
**AUXILAB AUTOCLAVES**  
**AUTOCLAVES AUXILAB**

Ref. | Code | Réf. ZCK016 - ZCK017



Este manual es parte integrante del aparato y debe estar a disposición de todos los usuarios. Le recomendamos que lea atentamente este manual y siga todos los procedimientos de funcionamiento, para obtener el mejor rendimiento y una mayor vida útil del aparato.

*This manual should be available for all users of these equipments. To get the best results and a higher duration of this equipment it is advisable to read carefully this manual and follow the processes of use.*

*Ce manuel fait partie intégrante de l'appareil, c'est pourquoi il doit être disponible pour tous les utilisateurs. Nous vous recommandons de lire attentivement ce manuel et de suivre toutes les procédures d'utilisation, afin d'obtenir les meilleures prestations et une plus grande durée de vie de l'appareil.*

## LANGUAGE INDEX

Spanish .....	2-17
English .....	18-33
French .....	34-49

## TABLE OF CONTENTS

1. Safety cautions .....	18
2. Introduction .....	18
3. Intended use .....	19
4. Parameters and programs .....	19
5. Control panel .....	20
6. Installation .....	26
7. Operation .....	27
8. Abnormal situations .....	28
9. Maintenance .....	30

### 1. Safety cautions



Please don't ignore these cautions, otherwise electric shock, fire or equipment damage may occur.

1. Use three holes socket ( $230 \pm 23\text{VAC}/10\text{A}/50\text{Hz} \sim 60\text{Hz}$ ) and be sure the socket is connected to the ground. Do not put the device in a place where it is very difficult to cut off the power.
2. Don't use any other voltage powers.
3. Never touch the plug or the socket with wet hands.
4. Don't pull, change, over-bend or twist wire, or don't leave heavy things on wire.
5. Don't put the sterilizer on surfaces which could cause a fire or fume.
6. Don't block the sterilizer's ventilation and radiation.
7. Don't put anything on the sterilizer.
8. If the user smells or hears abnormally during running (it doesn't include the noise of pumps), then cut off the power and contact your distributor.
9. Cut off the power if the sterilizer won't be used for a long time.

### 2. Introduction

This steam sterilizer is used by doctors or professionals and is designed especially for clinics, hospitals, laboratories, etc. It uses a microprocessor for smart control system. The interface is intuitive, allowing the equipment to be operated easily. The parameters and conditions of the sterilizer will be displayed on the digital screen during the process. For ensuring the reliability of sterilization, the machine will do trouble self-diagnose and self-protect automatically during overheat or overpressure situations. Inside the sterilizer there is a collector of condensate water that prevents the steam from polluting the environment.

### 3. Intended use

This autoclave is designed for sterilization of invasive medical instruments to prevent cross infection. It is widely used in hospital departments, stomatology clinics and biological research institutes. Can be sterilized wrapped or non-wrapped objects, solid objects, hollow objects and porous objects as represented by the test loads in the standard "EN13060:2004+A2:2010". This sterilizer can also be used in non-medical and veterinary applications.



Don't sterilize liquids!

### 4. Parameters and programs

#### Parameters

- Sterilization temperature: 105-134°C
- Sterilization time: 4-60 minutes
- Maximum working pressure: 0.21-0.23 MPa
- Vacuum cycles: 1-10
- Drying time: 1-25 minutes
- Ambient temperature: 5-40°C
- Relative humidity: ≤ 80%

#### Programs

Process	Vacuum cycles	Sterilization time	Sterilization temperature	Sterilization pressure	Vacuum persist time	Drying time
121 °C / SOLID	1 *	20 min *	121 °C	110 kPa	/	3 *
121 °C / POROUS	3 *	20 min *	121 °C	110 kPa	/	7 *
121 °C / HOLLOW	3 *	20 min *	121 °C	110 kPa	/	10 *
134 °C / SOLID	1 *	4 min *	134 °C	210 kPa	/	3 *
134 °C / POROUS	3 *	4 min *	134 °C	210 kPa	/	7 *
134 °C / HOLLOW	3 *	4 min *	134 °C	210 kPa	/	10 *
USER DEFINED	3 *	5 min *	134 °C *	210 kPa	/	10 *
B-D TEST	3	4 min	134 °C	210 kPa	/	7
VACUUM TEST	/	/	/	-80 kPa	15 min	/
CLEANING	3	5 min	105 °C	20 kPa	/	10
PRIONEN	3	19 min	135 °C	210 kPa	/	10

The values with \* can be adjusted.



B-D Test: Countdown on the display shows 4min, but normally it takes 3.5min.

## 5. Control panel

### LCD screen

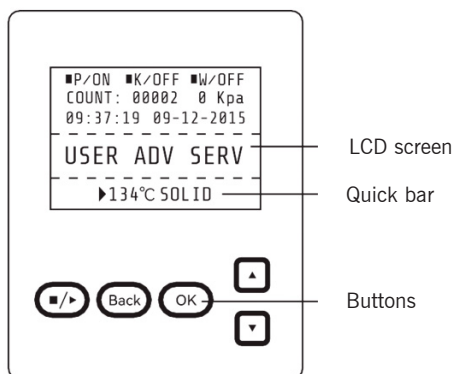

1. ■ **P/ON:** Indicates the status of the printer.

The related menu:

“ADV - PRINTER: ON/OFF”

ON indicates that the printer can work. OFF indicates that the printer can't work.

The user can change the printer's status in menu:

“ADV - PRINTER: ON/OFF”

2. ■ **K/OFF:** Indicates the status of function “Keep temperature”.

The related menu:

“ADV - KEEP TEMP: ON/OFF”

ON indicates that the sterilizer will heat the chamber and steam generator to preset temperature. When the door is opened, the sterilizer will stop heating the chamber and steam generator. The longest time to keep temperature is 8 hours. Setting it on can shorten the time of the whole cycle.

The user can change the option of “keep temperature” in menu:

“ADV - KEEP TEMP: ON/OFF”

3. ■ **W/OFF:** Indicates the status of function “Preheat”.

The related menu:

“ADV - PREHEAT: ON/OFF”

ON indicates that if user runs a program, the sterilizer can't execute the next step until the temperature in chamber reach 50 °C.

The user can change the option of “preheat” in menu:

“ADV - PREHEAT: ON/OFF”

If the user sets ■ W/ON the sterilizer will take very long time to finish the whole cycle.



The standards of some countries require this function; please check your local standards and set it accordingly.

4. **COUNT**: Indicates the number of runned sterilization programs.  
00023 indicates that the sterilizer has ran 23 programs (B&D/Helix and vacuum tests are not counted).
5. **Kpa**: Indicates the pressure in the chamber; when the sterilizer's door is opened, this pressure is the local air pressure.
6. **09:37:19 : Time**  
The user can set it in menu: "ADV - DATE/TIME"
7. **09-12-2015 : Date**  
The user can set it in menu: "ADV - DATE/TIME"
8. **USER** (user menu)  
All programs are in this menu. The user can select the required program in this menu.
9. **ADV** (advanced menu/set menu)  
The user can change options and set the parameters in this menu.
10. **SERV** (service menu)  
This menu is for maintenance, only the authorized personnel can enter it with password, the user can not enter it.
11. **134°C SOLID** (shortcut area)  
The equipment can record the program which was used last time. The user does not need to enter USER menu to select the same program.

## USER menu

There are eleven processes for user to select.

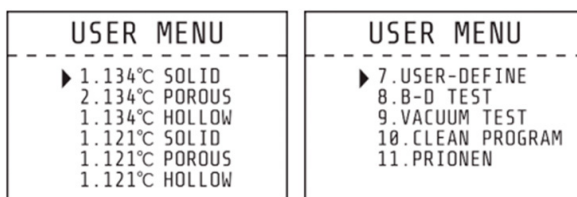

121 °C programs and 134 °C programs have no difference in sterilization results. Please use 121°C programs for instruments with temperature resistance below 134 °C.

Programs for solid objects can sterilize solid instruments, such as plier, forfex, forceps, etc.

Programs for porous objects can sterilize the loads which are made of porous material.

Programs for hollow objects can sterilize the hollow A and hollow B loads.

In the user-defined program, all these parameters can be adjusted: sterilization temperature, sterilization time, drying time and vacuum cycles.

B-D test is for hollow A loads test. B-D test and Helix test use the same test program; the only difference is that B-D test uses a B-D test package, while Helix test uses a Helix test device (PCD: process challenge device).

Vacuum test is air leakage test.



It is recommended to perform a vacuum test once a month. If the result is FAIL, don't use the device.

Cleaning program is used to clean the pipeline of the equipment. When the sterilizer displays the prompt of "NEED CLEAN", it shall run this program to clear this display.

Prion program is used to inactivate prion virus (for example, the mad cow virus).

## ADV menu

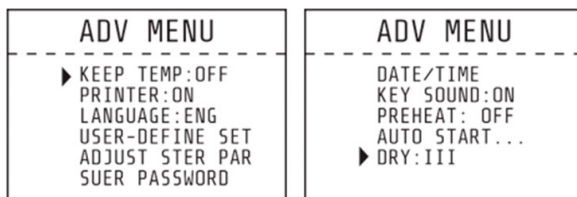

### ► Cursor

User can press button "up" or "down" to move cursor.

When the cursor is before the option which user want to set, user can press "OK" to change the setting.

#### 1. KEEP TEMP

The related parameter is "■ K" in first page.

ON: The sterilizer will heat the chamber and steam generator to preset temperature, when the door is opened, the sterilizer will stop heating the chamber and steam generator. The longest time to keep temperature is 8 hours. Setting it on can shorten the time of the whole cycle.

OFF: The sterilizer will not heat the chamber and steam generator.

#### 2. PRINTER

ON: The printer will print the records during the working cycle.

OFF: The printer will not print the records during the working cycle.

#### 3. LANGUAGE

English and Spanish are the languages available.

#### 4. USER-DEFINED SET

Setting of the program "USER-DEFINED". When the cursor is before this option, user can enter detailed setting page by pressing "OK". The detailed setting page:

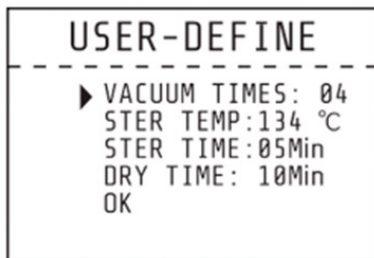

VACUUM TIMES: Setting of vacuum times during the sterilization cycle.

04: Means that the program “USER-DEFINED” has 4 cycles of vacuum process. The range of the “VACUUM TIMES” is 1~10.

STER TEMP: Setting of sterilization temperature.

134 °C: The temperature of program “USER-DEFINED” is 134 °C. The range of the “STER TEMP” is 105 °C ~134 °C.

STER TIME: Setting of sterilization time.

05Min: The sterilization time of program “USER-DEFINED” is 05Min. The range of the “STER TIME” is 04min-60min.

DRY TIME: Setting of drying time.

10Min: The drying time of program “USER-DEFINED” is 10Min. The range of the “DRY TIME” is 01min-25min.

OK: Save setting and return to the page of the upper.

## 5. ADJUST STER PAR

When the cursor is before this option, the user can press “OK” to enter the program selection page. There are six sterilization programs that can be adjusted.

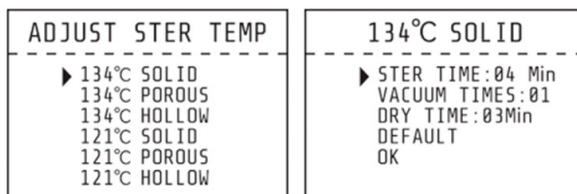

By pressing “UP” or “DOWN” buttons you can select the program you want to adjust. Press “OK” to enter the next page. For example, 134 °C SOLID.

There are three parameters that can be adjusted: STER TIME, VACUUM TIMES and DRY TIME. The setting method is the same as the setting of user-defined program.

DEFAULT: Return to default parameters.

Move the cursor to the “DEFAULT” option, press “OK”, press “UP” to establish the default parameters.

## 6. USER PASSWORD

To establish the user password set "ENABLED" to "ON". When the sterilizer is turned on, the user must input the correct password first, if the password is not correct, user can't use the sterilizer.

If user forgets the password, please contact the distributor.

When the cursor is before the "USER PASSWORD" option in "ADV" menu, press "OK" to enter the next page.

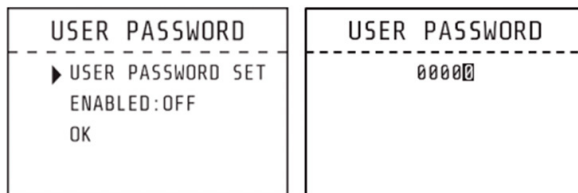

### USER PASSWORD SET:

When the cursor is before the "USER PASSWORD SET" option, then press "OK" to enter the next page.

The user can change the "0" with white fill by pressing "UP" or "DOWN" buttons.

UP: +1 DOWN: -1

Press "START/STOP" button to change the place of the digit you want to change.

ENABLED:

ON: the password you have set works.

OFF: the password you have set can't work.

OK: Return to the page of the upper.

## 7. DATE/TIME

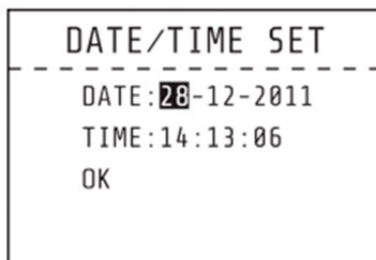

When the cursor is before the "DATE/TIME" option, press "OK" to enter the next page.

Press "UP" or "DOWN" to change the date:

UP: +1 DOWN: -1

Press "START/STOP" button to change the place of the digit you want to change.

## 8. KEY SOUND

When the cursor is before the "KEY SOUND" option, press "OK" to change "ON" or "OFF".

ON: key with a sound when pressed

OFF: key without a sound when pressed

## 9. PREHEAT

The related parameter is "■ W" in first page.

When the cursor is before the "PREHEAT" option, press "OK" to change "ON" or "OFF".

ON: If user runs a sterilization program, the sterilizer can't execute the next step until the temperature in chamber reaches 50 °C.

## 10. AUTO START

User can set the selected program to automatically run at the set time.

When the cursor is before the "AUTO START..." option, press "OK" to use this function.

After pressing "OK" button, you can set the time for the sterilizer to run automatically. There are two ways to set the time:

DATE TIME: The exact time when the sterilizer runs automatically.

XX HOUR LATER: To set how long time later the sterilizer runs automatically.

<b>AUTO START</b> <hr/> ▶ DATE TIME... XX HOUR LATER...	<b>DATE/TIME SET</b> <hr/> DATE: 12-11-2013 TIME: 09:03:09 OK	<b>HOUR LATER</b> <hr/> Hour: 00 Min : 00 OK
---	--	---

How to set DATE TIME:

Press "UP" or "DOWN" to change date/time:





UP: +1 DOWN: -1

Press "OK" button to change the place of the digit you want to change.

After setting date/time user must select the program to be run, then after pressing "OK", the time will count down, and the selected program will automatically run when the time arrives.

<b>USER MENU</b> <hr/> ▶ 1. 134°C SOLID 2. 134°C POROUS 3. 134°C HOLLOW 4. 121°C SOLID 5. 121°C POROUS 6. 121°C HOLLOW	<b>134°C SOLID</b> AUTO START AT: 10:06:44 12-11-2013 09:07:29 12-11-2013	<b>134°C SOLID</b> AUTO START...00:56:30
--	--	---

## Buttons

1. UP button:  move up or left
2. DOWN button:  move down or right
3. BACK button:  return to menu of the upper
4. OK button:  confirm or enter the next menu
5. START/STOP button:  after the program is selected and confirmed, the prompt “please press the START key to start...” appears. Press the START/STOP button to start the program. When the program is running, press the START/STOP button to finish the program.

## 6. Installation

Once you receive the product, open the box cover using a screwdriver. Then take the autoclave out using the ropes.

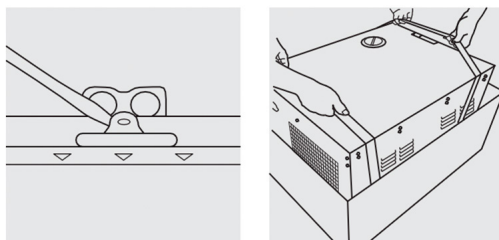

1. At least 10 cm space should be left around the sterilizer, and the back space must be at least 20 cm. The sterilizer should be put in well-ventilated location. Don't block the radiator of the sterilizer.



Make sure the worktop is strong enough to put the device on.

2. Adjust atmospheric pressure before the first time use since atmospheric pressure varies from place to place.

Steps: 1) Cut off the power 2) Open the door 3) Turn on the power, and after 20 minutes, cut off the power, it is done automatically.



If the user does not adjust the atmospheric pressure the sterilizer might not be able to run.

3. Adjust the date and time.

## 7. Operation

### Preparation before using

Before starting to use the sterilizer, please connect the power, press the main power switch. If the indication lamp of this switch is on and LCD screen is also on, that indicates the power of the sterilizer is on. At this time, the program of the sterilizer is in initial status, and the sterilizer does not heat.

### Water filling

After opening the power switch of the sterilizer, if LCD screen displays the prompt “please fill water” and there is beep, that indicates that the water level in the water tank is too low. At this time the program can't work until the water is added to the tank.

The water filling in this sterilizer is manual. On the top of the sterilizer there is access to water tank. When the water level in the water tank reaches above the alarm water level, the water shortage prompt will display on LCD and the beep appears. Fill the water until you hear “du”, it indicates that the water tank is full.



Please use distilled water to avoid clogging of the steam generator and the valves.



1. Before topping up water, the power must be connected.
2. Please do not put the sterilizer upside down when tank is full.
3. Suggestion: Drain the waste storage tank also when the water in the storage water tank is used out.

### Data recording

If you want to record the data, insert a flash memory into the USB port.

### Operation

When water tank has enough water and waste water tank is not full, the sterilizer is ready for work.

1. Put the loads into the chamber



1. No more than 70% of the volume of the sterilizer or no more than 3kg in model AXL8L/4.5kg in model AXL12L.
2. The instruments should not touch the inside wall, especially should not block the outlet of the chamber. It should leave at least 10 mm from the inside wall.
3. Put the test paper into the center of the sterilization package, if the user wants to test and judge the sterilization effect.
4. When putting the loads into the sterilizer, it is suggested the use of the plastic handle to prevent from being scalded.

## 2. Setting

Set the parameters KEEP TEMP, PRINTER, PREHEAT.

## 3. Door closing

If the door is not closed correctly, when you select the program and press “OK”, the LCD screen will display the message “Please close the door”.



If the user feels the handle is too hard to turn, there may be steam still in the sterilizer; we suggest closing door quickly or waiting for a few seconds to close the door.

## 4. Choosing program and starting

After the door is closed, choose the sterilization program according to the loads in the chamber. All the programs are in “USER” menu. Move the cursor to “USER” by pressing “UP” or “DOWN” buttons. Press “OK” to enter. Move the cursor before the right program by pressing “UP” or “DOWN” and press “OK” to select this program. The LCD screen will display “please push the start key to start”, then press “START/STOP” button to run this program.

The autoclave will run pre-heating, vacuum cycles, sterilization and drying automatically. The time of the whole cycle is determined by the initial temperature, the loads and the program.

When the program is finished, LCD screen will display “END” with three beeps. The user can open the door and take the sterilized loads out.

5. When the sterilizer is not in use, please turn off the power switch (be sure the lamp is off). If the user won't use the autoclave for a long time, please disconnect the power.

## 6. Suggestions:



The user shall fill in water promptly if there is a low-water alert, otherwise, the sterilizer will show “E8 or E9” error alarm.



1. Use the plastic handle to take the tray out of the sterilizer to prevent scalding.

2. Don't open the door until the pressure within “-05~05”.

To verify the effectiveness of sterilization, we suggest putting indicator paper or pouches with indicators together with the loads into the sterilization chamber.

7. If LCD screen displays “PLEASE DRAIN WATER FROM WASTER WATER TANK!”, this mean the waste water tank is full, you must drain water.



The waste water may be hot, be careful to avoid scalding.

## 8. Abnormal situations

The sterilizer will give alarm, release pressure and stop heating automatically if it has any abnormal situations during work. It will absolutely keep the user safe and display the error code (see the table below). Write down the error code No. and cut off the power. Don't open the door and then turn on the power again to wait the pressure turn back to “-0.5~0.5”.



We suggest running one more time to see if the error happens again.

If the user cannot find the resolution from the table, contact your distributor to get technical assistance, indicating the error code No.

Item	Code	Alarm	Reason	Resolution
1	E31	Continuous beep	Temperature in chamber > 150 °C	Check temperature sensor in chamber.
2	E32	Continuous beep	Temperature outside of the heating ring >280 °C	Check temperature sensor outside of the heating ring.
3	E51	Continuous beep	Temperature in chamber ≤ 0 °C	Check temperature sensor in chamber. Check the temperature of the place where the sterilizer put on is below 0°C or not
4	E52	Continuous beep	Temperature outside of the heating ring ≤ 0 °C	Check temperature sensor outside of the heating ring. Check the temperature of the place where the sterilizer put on is below 0°C or not.
5	E63	Continuous beep	1.Steam generator temperature ≤ 0 °C 2. Steam generator temperature >230°C Steam temperature control instability, over 230 °C, steam generator temperature sensor damaged	Check steam generator temperature sensor, control board, steam generator.
6	E2	Continuous beep	The sterilization pressure over preset pressure +0.4bar (134°C process over 3.5bar(absolute pressure)(121°C process over 2.5bar)vacuum unusually have many air remain in chamber.	Check vacuum pump. Do a vacuum test.
7	E61	Continuous beep	134°C process: inner temperature >140°C or 121°C process: inner temperature >127°C, temperature control instability.	Check temperature sensor in chamber.
8	E62	Continuous beep	Temperature outside of the heating ring >155°C, temperature control instability, control board damaged.	Ask professional check temperature sensor outside of the heating ring, control board, heating ring.
9	E41	Continuous beep	In preheat period, after 8mins temperature outside of the heating ring <100°C, heating circle damaged.	Check heating ring.
10	E42	Continuous beep	In preheat period, after 8mins steam generator temperature <110°C, heating rod damaged.	Check heating rod.
11	E5	Continuous beep	When the period of "sterilization" finished. Drain for 10mins, the pressure in chamber still over 0.5bar; air relief instability.	Check water drain valve.
12	E6	Continuous beep	The door opened during sterilization period; the door detector switch damaged.	Check door detector switch.

Item	Code	Alarm	Reason	Resolution
13	E7	Continuous beep	The local air pressure value <70KPa.	Can not be used in this area. Adjust atmospheric pressure.
14	E8	Continuous beep	In rise period, every 5mins temperature rise <3 °C.	Check water pump, heating rod, control board. Check water tank has enough water.
15	E9	Continuous beep	In sterilization period, the sterilization pressure below the preset pressure -0.3bar.	Check the water tank has no water.
16	E10	Continuous beep	The electromagnet in wrong condition (power on, the electromagnet at close condition; process start, the electromagnet at open condition; process finished, the electromagnet at close condition)	Check electromagnet, control board.
17	E11	Continuous beep	The electromagnet at open condition during running; the port on control board which use to control electromagnet damaged.	Check control board.
18	E12	Continuous beep	The vacuum not reach -70Kpa 2 times during the program which have 3 times vacuum.	Check vacuum pump.
19	E14	Continuous beep	The water tank triggers low-level and high-level alerts simultaneously.	Replace the high-level sensor or low-level sensor sequentially.
20	E15	Continuous beep	The water quality system has problem.	Check the water quality sensor and PCB.
21	E99	Continuous beep	The communication between CPU is wrong.	Check control board data line, and CPU install.

## 9. Maintenance

The parts must be regularly checked or replaced.

Item	Operator	Frequency	Maintenance
Door	Technician	2 years	See 1
Seal ring	User	1 year	See 7
Printer paper	User	When the printer has no paper	See 2
Safety valve	Technician	1 year	See 8
Water tank level sensor	User	6 months	See 9
Water quality module	User	6 months	See 10

## 1. Door tightness adjustment

Door adjustment:

Push down the lever while turning the door to adjust tightness. As shown in the picture below, anticlockwise turning will tighten the door, i.e, the door will be closer to the chamber. Therefore, it needs more strength to turn the handle. With clockwise turning the door will loosen it.

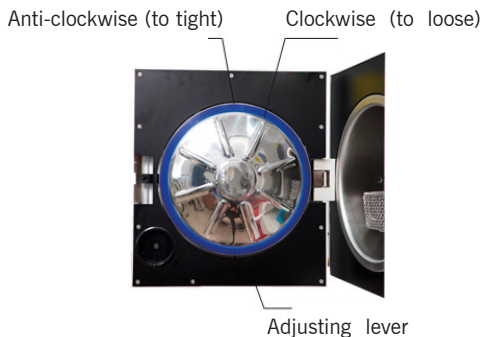

Steps:

- Push down the lever a little
- Turn the door a little
- Release the lever
- Keep turning the door to a place where the door cannot move anymore

 After the door adjustment, it is necessary to perform a vacuum test. If there is a leakage, the user must adjust it again.

 If the door is too loose, the sealing ring might be exploded out with a big “bang”. So, please be careful when performing the door adjustment!

## 2. Changing printer paper and checking paper feed

Printer paper change:

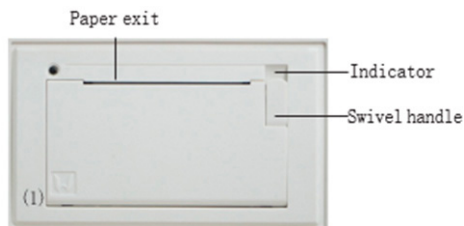

Press “open” button to open the printer door. Change the paper.

Check whether the paper change is correct through paper feed.

Printer paper feed check:

When press “LF” button once to see if the paper feed in gear; if the paper feed out of gear, the paper jammed, then change paper and feed again.

If the printer paper feed is correct, but there is no data on the paper, please install the printer paper again. The printer paper has direction and only one side can be printed on.

3. Use disinfectant to clean the water tank every week.
4. Use ethyl alcohol to disinfect the inner surface of the sterilizer every month.
5. Every 150 cycles, it is recommended to replace the germ-tight filter.
6. Clean the seal ring regularly

For keeping a good ability of seal, the user should clean the seal ring regularly. Clean the seal ring with distilled water. If leaking still happens after cleaning, the user may have to replace the seal ring.

#### 7. Replacing the seal ring

Tool: The user will need a screwdriver without sharp tip.

- A. Hold the seal ring with one hand and use another one to hold a screwdriver carefully to separate the door and the seal ring. Then take the seal ring out slowly.
- B. After the user takes the seal ring out, clean and check it, if it is damaged, the user must replace it.
- C. After the seal ring is cleaned, put it back.
- D. Attention: if the user finds it hard to put the seal ring back, use screwdriver press it carefully until it is done.

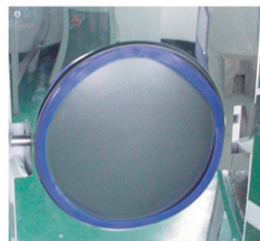
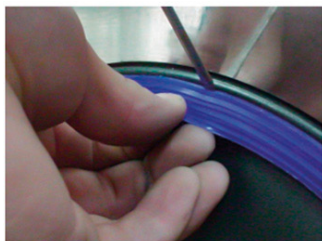

#### 8. Replacing the safety valve

- A. Remove the part 1 shown in the picture below, then remove the tube which connects the safety valve.
- B. Remove part 2 shown in picture below.
- C. Replace the safety valve.





The new safety valve must be the same model. If user can't find the same safety valve, please contact the distributor.

Never maintain and repair the sterilizer until the power is disconnected and it is cooled down to prevent scalding. Repairing the sterilizer must be done by well-trained professionals.

#### 9. Checking the water tank low-level sensor

With the device powered on, press the shortcut key to access the operation interface. Drain the water tank completely. If WATER DEFICIENCY ALERT appears on the interface, the sensor functions correctly. If no alert appears, contact the distributor and report the fault.

#### 10. Checking the water quality function

With the device powered on and water present in the tank, use a conductor (e.g. tweezers, scissors) to short-circuit the two probe pins of the water quality sensor. Maintain the contact for 5-10 seconds. If WATER QUALITY ALERT appears on the interface, the function is normal. If no alert appears, contact the distributor and report the fault.