

**CENTRÍFUGA REFRIGERADA DE BAJA VELOCIDAD HICAP+
HICAP+ LOW SPEED REFRIGERATED CENTRIFUGE
CENTRIFUGEUSE RÉFRIGÉRÉE À BASSE VITESSE HICAP+
(ROTOR 250 mL)**



MODELO - MODEL - MODÈLE 2761R



Este manual es parte inseparable del aparato por lo que debe estar disponible a todos los usuarios del equipo. Le recomendamos leer atentamente el presente manual y seguir rigurosamente los procedimientos de uso para obtener las máximas prestaciones y una mayor duración del mismo.

This manual should be available for all users of these equipments. To get the best results and a higher duration of this equipment it is advisable to read carefully this manual and follow the processes of use.

Ce manuel est une partie indissociable de l'appareil et doit être mis à la disposition de tous les utilisateurs de l'équipement. Nous vous recommandons de lire attentivement ce manuel et de suivre scrupuleusement les procédures d'utilisation afin d'obtenir des performances maximales et une plus longue durée de vie de l'appareil.

LANGUAGE INDEX

| | |
|---------------|-------|
| Spanish | 2-27 |
| English | 28-53 |
| French | 54-79 |

DEVICE WORKING ENVIRONMENT



To ensure the safety of the machine, consider the following factors that may damage the centrifuge:

- Chemical effect.
- Environmental impacts, including natural ultraviolet radiation.
- Corrosion and wear of protective cover parts and other safety parts.
- Indoor use
- Altitude ≤ 2000 m
- The applicable ambient temperature range is $+ 5^{\circ}\text{C} \sim + 40^{\circ}\text{C}$
- The applicable relative humidity range is $\leq 80\%$
- Power supply 220 VAC, 50/60 Hz
- Enough ventilation equipment must be installed in the room
- No vibration and airflow that affect the performance
- No conductive dust, explosive gases and corrosive gases in the surrounding air

SAFETY TIPS

- Before using this machine for the first time, please read this manual carefully.
- This centrifuge can only be operated by trained and authorized personnel.
- The repair of the equipment can only be completed by the authorized Technical Service.
- Never use the following materials in the centrifuge:
 - Inflammable and explosive materials
 - Strong chemical-action materials
 - Toxic or radioactive substances, or pathogenic microorganisms, etc.
- Only qualified maintenance personnel can perform maintenance operation on the centrifuge with appropriate tools.
- Use the accessories provided by the manufacturer. If the user wants to use other accessories, the company will not be responsible for the adverse consequences caused.
- This centrifuge must be inspected and maintained at specified time intervals.

DESCRIPTION OF THE SAFETY WARNING SIGNS



Note: Please read the instructions carefully before using the centrifuge!



Note: High voltage danger! Danger of electric shock!

THE MEANING OF THE SAFETY INSTRUCTIONS

In order to avoid damage to personnel, surrounding objects and environment, please observe all safety instructions in this user manual.

In addition to the recognized occupational rules on accident prevention, environmental protection and in terms of safety and occupation, the local laws and regulations of the country of the user of the centrifuge must be carefully observed.

CONSEQUENCES OF IGNORING THE SAFE OPERATING PROCEDURES

Any neglect of safety operating procedures, laws and regulations and various rules will lead to harm to personnel, objects and the environment.

TABLE OF CONTENTS

| | |
|---|----|
| 1. Safe terms of use | 31 |
| 1.1 Operation precautions..... | 31 |
| 2. Introduction..... | 32 |
| 2.1 Appearance | 32 |
| 2.2 Overview..... | 32 |
| 2.3 Introduction to the equipment structure | 33 |
| 2.4 Safety protection | 34 |
| 2.5 Machine placement requirements..... | 34 |
| 3. Optional accessories..... | 35 |
| 4. Preparation before use..... | 35 |
| 4.1 Transport and installation | 35 |
| 4.2 Select a reasonable settlement site..... | 36 |
| 4.3 Position the machine firmly | 36 |
| 4.4 Connect the power supply correctly | 36 |
| 5. Operating instructions..... | 37 |
| 5.1 Introduction to control panel and display interface | 37 |
| 5.2 Boot | 38 |
| 5.3 Opening the door | 38 |
| 5.4 Closing the door..... | 38 |
| 5.5 Installing the rotor..... | 38 |
| 5.6 Calculation of rotor load..... | 39 |
| 5.7 Filling samples in centrifugal containers | 40 |
| 5.8 Safe use of rotor..... | 40 |
| 5.9 Example of parameter setting | 40 |
| 5.10 Other parameters setting..... | 41 |
| 5.11 Calculation of centrifugal force..... | 44 |
| 5.12 Running curve interface | 44 |
| 5.13 Main parameters setting interface | 45 |
| 6. Maintenance | 47 |
| 6.1 Cleaning / Decontamination..... | 47 |
| 6.2 Maintenance | 47 |
| 7. Fault treatment | 48 |
| 7.1 Opening the door in emergency | 48 |
| 7.2 Fault alarm information..... | 48 |
| 8. Technical data | 52 |
| 9. Packing list..... | 53 |
| 10. Warranty..... | 53 |

1. SAFE TERMS OF USE

The 2761R model centrifuge is designed according current technical and safety standards:

- **IEC61010-1:2001** Safety Requirements for Electrical Equipment for Measurement and Control Laboratories - Part 1: General Safety Requirements.
- **IEC61010-2-020:2006** Safety Requirements for Electrical Equipment Used in Measurement and Control Laboratories. Special Requirements for Centrifuges Used in Laboratories.
- **ISO780-1997** Pictorial Marks for Packaging, Storage and Transportation.
- **ICS19.040** Transportation Test of Electronic Measuring Instruments.
- **IEC60601** Environmental Requirements and Test Methods for Medical Electrical Equipment.

With the following incorrect or inappropriate use methods, equipment damage or personal injury may occur:

- Centrifuge is not used according to the design requirements.
- User and maintenance personnel are not trained.
- User makes inappropriate changes to the design without authorization.
- User did not notice or understand the safe use rules.



Any personnel involved in the use or maintenance of the centrifuge must read and understand the use method and safe use rules in this manual.

In addition, to prevent accidents, the following rules must be strictly implemented:

This manual is one of the components of the 2761R model centrifuge and must be placed with the device for consultation by the operator.

This low-speed centrifuge is designed for use in clinical medicine, biology, chemistry, genetic engineering, immunology, etc. The density of the sample separated at the maximum speed shall not exceed 1.2g/cm^3 ; when the density of the sample is greater than 1.2g/cm^3 , the maximum speed of the rotor must be reduced accordingly.

During the operation of the centrifuge, and within 30 cm around the centrifuge, there shall be no operator or harmful dangerous substances, and no objects blocking the centrifuge vent.

Take in consideration the following:

- The design of the centrifuge is neither corrosion-proof nor explosion-proof, so the centrifuge cannot be used in the environment with corrosion and possible explosion.
- Never use the following materials in the centrifuge:
 - Flammable and explosive materials
 - Strong chemical-acting materials
 - Toxic or radioactive substances, or pathogenic microorganisms, etc.
- For the isolation of corrosive substances and easily pathogenic microbial cells, effective sealing measures should be taken in advance, and effective disinfection measures should be carried out in time after use. For details, see "Maintenance -disinfection matters".
- Separation of corrosive substances will cause damage of the material inside the centrifuge or weaken the mechanical strength of the rotor, so when separating corrosive substances, they must be placed in a protective container.

1.1 Operation precautions

- Before the centrifuge operation, it must confirm the installation of suitable rotor and ensure firm installation.
- When the centrifuge is in the operation process (when the rotor is rotating) or in the stop process (but the rotor is still rotating), do not manually open the door and move the centrifuge.
- The parts used in centrifuge must be special parts provided by the manufacturer. For some general parts, such as plastic separation containers, must meet the requirements of the maximum speed of the rotor and maximum centrifugal force.

- Do not use the centrifuge or separate samples when the door is open.
- When moving the centrifuge to other place, first disconnect the power cord.
- The replacement of the mechanical parts and electronic devices of the centrifuge must be implemented by the relevant personnel designated by the company.
- Using the centrifuge, operators must choose the appropriate rotor load, and must not overload the rotor.
- Often check the rotor; if the rotor is found to have obvious corrosion traces or obvious damage, must stop using.
- After use for a period of time, maintenance should be strictly in accordance with the “cleaning and disinfection” regulations.

2. INTRODUCTION

2.1 Appearance

- | | |
|-------------------------------------|--|
| 1. Door cover | 7. Heat dissipation holes |
| 2. Observation window | 8. Power socket |
| 3. Hole for emergency door opening | 9. Electronic overload/short circuit protector |
| 4. Control panel and display screen | 10. Power switch |
| 5. Housing | 11. USB port |
| 6. Foot | |

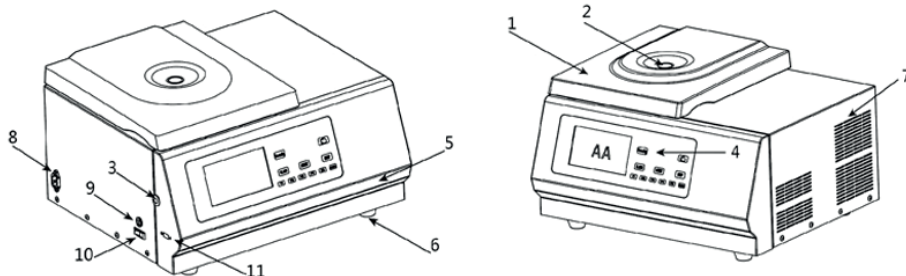

2.2 Overview

2761R model is a refrigerated low-speed high-capacity desktop centrifuge used for routine analysis in medical laboratories, biochemical and molecular biology research, and industrial laboratories. It can be widely used in clinical medicine, biology, chemistry, genetic engineering, immunology, and other fields. It can be used with different types of rotors (see Table 1: Rotor types and technical parameters).

2.3 Introduction to the equipment structure

This equipment consists of refrigeration system, door cover system, chamber system, drive system, rotor system, base system, power supply system, control system, display system, and alarm system.

■ The refrigeration system includes compressor, condenser, fan, etc. Adopting a powerful fluorine-free high-efficiency refrigerant R134a, the temperature control range is between $-20\text{ }^{\circ}\text{C}$ and $+40\text{ }^{\circ}\text{C}$, and it can also quickly precool the rotor in a stationary state. When the centrifuge door cover is opened, the refrigeration system will still ensure constant temperature operation at the set temperature to avoid icing in the rotor chamber.

■ The door cover system includes door cover, door hinge and damping gas spring, door lock, door alarm, emergency door lock mechanism, etc. The door hinge is located inside the rear of the rack, and the door lock is in front of the rack. Only when the door lock is locked can the centrifuge be started, otherwise the door alarm system will work (the buzzer will sound) and the machine will not start.

To open the door cover, simply press the open button on the machine control panel. When the door cover is opened to a certain height, the door hinge and damping gas spring can support the door cover. If there is a power outage or failure of the door opening key, and the samples must be taken out in a timely manner, it is necessary to use the supplied tool to insert it into the emergency door opening hole and rotate it clockwise for one and a half turns until the door cover is opened.



When the rotor is rotating and the power is turned on, it is strictly prohibited to use the emergency tool to open the door cover!

■ Chamber system includes a stainless steel inner liner and a rubber sealing ring. It can provide a stable working environment.

■ This equipment uses a variable frequency motor to directly drive the rotor of the load sample to rotate together. The drive system adopts a direct drive method, which ensures high precision in matching the rotor with the shaft and smooth operation.

■ The rotor system is composed of various rotors (see “Table 1: Rotor types and technical parameters” for details), centrifugal tubes and other related accessories. The function of the rotor is to rotate the load sample at a certain speed, creating a relative centrifugal force field, thereby achieving the purpose of separating the sample. Since the centrifugal force reached when the rotor rotates at low speed is thousands of times more than the gravitational acceleration g value of the Earth, it is very important for the safe use and careful maintenance of the rotor!

■ The base system consists of a rack, a base plate, a body shell, and rubber support feet.

■ The power supply system includes power sockets and switches, which are responsible for the mains power supply required for the normal operation of the machine.

■ The control system includes settings for rotational speed and centrifugal force, operating time, selection of acceleration and deceleration rates, control of the entire machine display system, and alarm system. To ensure the normal operation of the machine and the personal safety of the operator, please do not disassemble the machine casually!

■ The display system consists of a 7-inch color LCD touch screen and a PET touch keyboard panel (control panel). It is a medium for human-machine dialogue. It can synchronously display various parameters set and track the actual changes of various parameters. In addition, it can also display and alarm various faults.

■ The alarm system is equipped with alarms for door cover failure, overspeed, imbalance, overvoltage, etc. In case of overspeed, door cover opening, imbalance and other faults of the machine, the system will give an alarm. At this time, the buzzer will give an alarm sound, and an error code will appear in the middle of the screen. The machine cannot be started (it is not allowed to start). The running machine will automatically stop until the fault is eliminated, and the machine can be restarted. Note: To eliminate the alarm sound emitted by the buzzer, press the Stop button.

2.4 Safety protection

This centrifuge has a series of safety protection mechanisms:

The frame and protective steel ring are made of steel plates, and the chamber is made of stainless steel. The door cover adopts an explosion-proof structure, and there is a locking mechanism at the front of the door cover. Only when the centrifuge is powered on and the rotor is stopped you can press the open button on the control panel to open the door cover of the centrifuge. The centrifuge can only be started when the door cover is locked!

■ Overspeed

When the operating speed of the centrifuge rotor exceeds the set speed by 600rpm, the machine will sound an alarm. When the operating speed exceeds the maximum rated speed of the rotor by 600rpm, the rotor will automatically stop running. The door can only be opened after the rotor has completely stopped. After troubleshooting, the machine will restart.

■ Unbalance

If the rotor rotates unevenly during operation, causing the shaft to shake beyond the specified range, the machine will stop running in a timely manner and issue an alarm prompt; generally, the rotor load is unbalanced. After the operation is terminated, open the door cover, and after troubleshooting, the operation can be restarted.

■ Overtemperature

When the temperature in the centrifugal chamber exceeds the set temperature by 10 °C, the machine will stop running in a timely manner and issue an alarm prompt. It can only be restarted after cooling down in the centrifugal chamber.

■ Emergency opening

During the operation of the rotor, if there is a sudden power outage or machine malfunction that makes it impossible to open the door with a button, manual door opening can be used (see 2.3.2).

2.5 Machine placement requirements

■ The machine should be placed on a level table with sufficient rigidity and away from vibration and impact equipment, avoiding direct exposure to heat sources and sunlight.

■ There should be a space of 20cm to 25cm on all sides of this machine for ventilation and heat dissipation.

■ After placement, the level should be adjusted and the four supporting feet at the bottom of the equipment should be evenly supported on the table.

■ The power supply is 220VAC \pm 10%, 50/60Hz.

This machine must be strictly and reliably grounded, and the machine power grounding wire must be reliably connected to the power grid grounding wire! During the operation of the rotor, it is strictly prohibited to manually power off, otherwise it may cause damage to the control circuit!

3. OPTIONAL ACCESSORIES

Various rotors for 2761R model centrifuge are available for users. You can purchase the centrifuge according to your actual use requirements (see “Table 1: Rotor types and technical parameters” for details).

| Code | Capacity (mL×tubes) | Max. speed (rpm) | Max. RCF (×g) | Tube type |
|--------------------------------|---|------------------------|---------------------|-------------------------------------|
| 6R-1 (GNP020) | 250 mL×4 | 4000 | 3040 | PP, flat bottom with lid |
| 6R-1.1 (GNP013) | 50 mL×8+15 mL×8 | | | PP, cone bottom with lid |
| 6R-1.2 (GNP021) | 50 mL×8+5 mL (Vacutainer) ×16 | | | PP, cone bottom with lid |
| 6R-1.3 (GNP022) | 15 mL×28 | | | PP, cone bottom with lid |
| 6R-1.4 (GNP023) | 100 mL×4 | | | PP, round bottom with cover |
| 6R-1.5 (GNP024) | 5 mL×40 | | | 13×100mm Vacutainer |
| 6R-5 (angular rotor GNM008) | 15 mL×12 | 6000 | 5150 | PP, round/conical bottom with lid |
| 6R-6 (angular rotor GNP034) | 50 mL×8 | 6000 | 5150 | PP, round/conical bottom with cover |
| 6R-7 (GNP035) | 4 microplates × 2 × 96 2 deep well plates × 2 × 96 | 4000 | 2860 | 96-well plates |

4. PREPARATION BEFORE USE

4.1 Transport and installation

The centrifuge is transported using a packaging box, which contains buffer protection materials inside. After opening the packaging box, remove the buffer protection materials inside.



The weight of the machine is 95kg. When handling, lift the equipment from both sides of the machine and balance the force! Please handle vertically and do not shake the machine!

When transporting or transporting over long distances, please use specialized packaging boxes that are properly secured and maintained in a vertical position and should be handled with care.

4.2 Select a reasonable settlement site

This centrifuge can only be used indoors, and the location shall meet the following requirements:

- When the centrifuge is running, a safe distance of 30cm must be kept around, and hazardous substances shall not be placed within this safe distance, and personnel shall not stay.
- The support or table for the centrifuge shall be firm and not shaking or vibration. If movable support or trolley is used, a locking device shall be used to ensure the safe operation of the centrifuge.
- If the centrifuge is placed near the wall or in the corner, in order to ensure smooth air circulation and good heat dissipation, please ensure that the distance between the rear and the side of the centrifuge from the wall is not less than 15cm and 20cm, respectively.
- Centrifuge should be placed away from windows to avoid direct exposure to heat and sunlight.
- The four supporting feet should be evenly supported on the table and the level should be adjusted.
- The room for the centrifuge must be a constant temperature room with temperature between + 5°C and 40°C and a maximum ambient humidity of 80%. Keep the environment clean.

4.3 Position the machine firmly

Once the centrifuge is placed, do not move it at will. If you move it, re-confirm or adjust the level, and make the four supporting feet at the bottom of the machine be evenly supported on the table. Confirm that the support or table of the machine is firm and without vibrations.

4.4 Connect the power supply correctly

The power cord of the centrifuge should use a separate power socket, which must be well grounded. Confirm that the power cord used meets the safety specifications of the country and region where the centrifuge is located. The power voltage and frequency applicable to the centrifuge should meet the requirements specified in this manual or the specifications marked on the centrifuge nameplate. Please use the power cord provided with the machine, connect it correctly to the machine power socket, and connect it firmly to the network power supply. When the power switch is closed, it is “|”, and when the power switch is disconnected, it is “O”.

5. OPERATING INSTRUCTIONS

5.1 Introduction to control panel and display interface

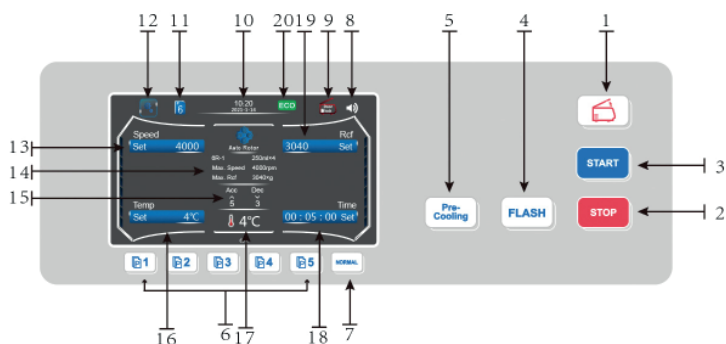

1. Door opening key
2. Stop key
3. Start key
4. Short centrifugation key
5. Pre-cooling/fast cooling setting key
6. Quick call keys for stored programs
7. Press this key during non-program operation to instantly set various centrifugal parameters (NORMAL)
8. Prompt tone status display
9. Door cover status display
10. Date and time display
11. Storage page settings display status
12. Secondary menu buttons
13. Set speed display
14. Rotor parameters display
15. Display area for acceleration and deceleration levels
16. Set temperature display
17. Real time temperature display
18. Set time display
19. Set relative centrifugal force display

Figure 4: Screen of running parameters

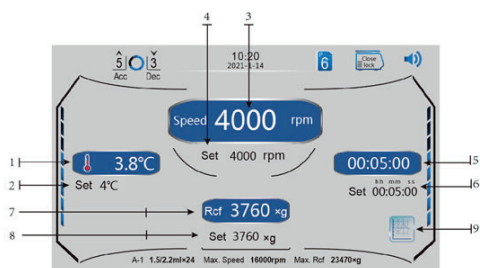

1. Real time temperature
2. Set temperature
3. Real time speed
4. Set speed
5. Real time
6. Set time
7. Real time relative centrifugal force
8. Set relative centrifugal force
9. Switch to the graph interface icon

5.2 Boot

Connect one end of the power cord supplied with the machine to the power socket, and the other end to the mains power supply. The mains power supply should use a separate socket. The power supply used in this machine is 220ACV \pm 10%, 50/60Hz. After connecting, turn on the power switch located on the left side of the machine. The LCD color display on the control panel lights up. After the self-inspection of the machine is completed, enter the Home screen, and now you can proceed to the next step.

5.3 Opening the door

Press the door opening key on the control panel, the buzzer will sound a prompt sound. The status display area shows the symbol of open door, and then the door cover needs to be lifted by hand to fully open it, and the inner chamber will be presented to the user.

Note: If a malfunction occurs and the door cover cannot be automatically opened, if it is necessary to remove the samples inside the chamber, the manual door opening method can be used, as detailed in “2.3.2”.

5.4 Closing the door

Grip both sides of the door cover with both hands, and gently close the door cover. After the door cover is locked, the machine will sound a “Didi” prompt and the “Door Cover Status Display Symbol” on the screen will light up the door cover closed status. Note: If the door cover is not properly closed, the centrifuge will not run. Please confirm that the door cover is closed properly.



When closing the door, please slowly close it with both hands and do not use excessive force to prevent damaging the locking hook!

5.5 Installing the rotor

The rotor used must be the original rotor of the centrifuge manufacturer. This manual indicates various rotor models from manufacturer (see “Table 1: Rotor types and technical parameters” for details).



The use of inappropriate rotors and centrifuge tubes can lead to poor centrifugation results and even damage to the centrifuge!

- Turn on the power switch and wait for the self-check to complete.
- Press the door opening key , open the centrifuge door cover and confirm that the chamber is clean and free of foreign objects.
- Clean the surface of the motor spindle.
- As shown in Figure 5, prepare the rotor you want to use. Hold the rotor with both hands, align the center hole of the rotor with the motor spindle, place it vertically and at the bottom of the conical surface of the spindle. Release both hands, press the rotor down with your hands again.
- Use the tool (special hexagonal key) to tighten the locking nut clockwise.

Figure 5: Schematic diagram of installing the rotor



After installing the rotor, check whether the installation position of the rotor has changed before each use or after a period of use. If necessary, tighten the locking nut again to ensure that the rotor is securely installed.

5.6 Calculation of rotor load

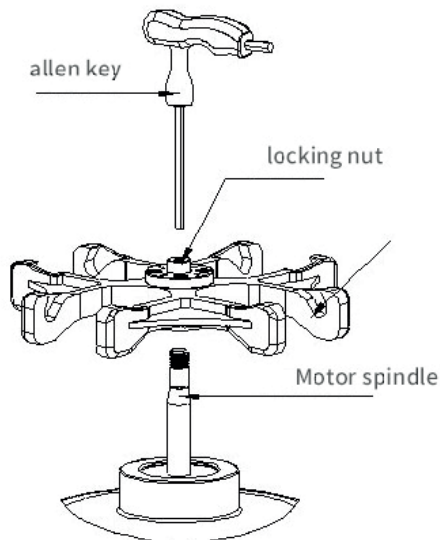
■ Calculation of maximum load

When the centrifuge operates at low speed, there is a huge centrifugal force. When designing each rotor, it is required to have sufficient mechanical strength when working at the maximum rated speed - that is, should have a “factor of safety”; however, this “factor of safety” requires that the rotor load shall not exceed its maximum rated load.

If the total amount of sample exceeds the maximum rated load of the rotor, you must reduce the weight of the sample or calculate the allowable operating speed of the rotor (NPERM); ensure that the rotor load does not exceed its maximum rated load.

The calculation method for the allowable operating speed (NPERM) of the rotor is as follows:

$$NPERM = N_{max} \times (\text{maximum permissible load} \div \text{actual load})^{0.5}$$

N_{max} : Maximum rated speed



Do not overload the rotor, otherwise it may cause an explosion, and the debris generated can damage the centrifuge!

5.7 Filling samples in centrifugal containers

When the centrifuge is running, the better the rotor balance performance is, the better the centrifugation effect achieved. Therefore, the samples shall be filled into the centrifugal containers as evenly as possible, to achieve a better balance effect during operation. All samples must be placed in suitable containers.

Carefully check whether the container (centrifuge tube, etc) used complies with the maximum allowable rated acceleration (centrifugal force); if the requirement is met, please reduce the running speed for use, whenever possible.



Please pay attention to the service life of the centrifugal container used, especially when operating at the maximum allowable load and speed. Centrifugal containers used should be checked for damage and replaced in a timely manner.

5.8 Safe use of rotor

■ Before the rotor runs, the samples (centrifugal containers) should be accurately and symmetrically loaded.

■ The swing out rotor shall not operate for a long time in the 900rpm critical speed, otherwise the machine will produce large vibration and affect the service life.



When the locking nut of the rotor is not tightened on the motor shaft, it is strictly prohibited to start the machine!



■ If the centrifuge needs to be operated repeatedly, the locking nut must be checked for looseness after several uses. If there is looseness, it must be tightened before starting up and running.

■ Centrifugal tubes must be symmetrically loaded (with a permissible weight error of $\leq 1.5g$). When loading samples asymmetrically, it is never allowed to start running.

5.9 Example of parameter setting

For example, using the 6R-1 rotor (250 mL \times 4), the specific operation is as follows: turn on the power - turn on the power switch - the LCD display will light up. The following parameters need to be set:

| Rotor | Speed (rpm) | Time (min) | Temp °C | ACC | DEC |
|-------|-------------|------------|---------|-----|-----|
| 6R-1 | 4000 | 30 | 4 | 5 | 3 |

Set up:  Press this key to cancel the memory operation and set various centrifugation parameters. At this time, the storage icon “P+number” on the display screen  will be hidden.

Rotor number setting: The device automatically recognizes the rotor model without setting, and the rotor number display area shows a numerical value during automatic recognition ; when a fault occurs in automatic recognition, please refer to Section 5.10.7 for manual setting.

Temperature setting: Click on the Temperature module on the screen - input parameter to set the temperature to 4.0.

Speed setting: Click on the Speed module on the screen - input parameter to set the speed to 4000. Note: The Rcf value is automatically converted with the speed value.

Time setting: Click on the Time module on the screen (time is divided into three touchable areas: hours, minutes, and seconds) - enter the required time.

ACC/DEC setting (the acceleration and deceleration settings for starting the machine to the set speed and stopping the machine from running, with values ranging from 0 to 9. The higher the value, the shorter the time it takes): Enter the second level menu interface. Note: When DEC is set to 0, the shutdown is free, and the system has no brake intervention.



5.10 Other parameters setting

■ During the process of setting parameters, if an alarm occurs due to machine malfunction or incorrect parameter settings, press the **STOP** key to cancel the alarm and reset it according to the rotor number.

■ Press the **START** key and the machine will start running (if you need to stop midway, please press the **STOP** key). The time will gradually decrease from the set value to zero. When the time value is displayed as zero, the centrifuge will automatically stop. At this time, the speed will gradually decrease from the set value to zero (the time taken for the speed to decrease from the set value to zero is related to the deceleration setting). When the speed becomes zero, the machine will emit shutdown sound. Press the **STOP** key to stop the sound. Centrifugation completed.

■ **If short time centrifugation is required:** Please press and hold the **FLASH** key on the control panel, and the speed will continue to increase. Release the key to stop. The maximum speed during this time will be the set speed corresponding to the rotor number. Time increases in seconds.

■ **Reminder tone setting:** Enter the menu interface for settings.

■ **Storage memory setting:** The centrifuge provides 30 custom memory programs for different experimental parameters. For P1-P5 shortcut keys on the control panel are used. For P6-P30, please press the  storage icon on the screen to enter. To cancel storage and switch to normal operation mode, press the  key.

■ **Pre-cooling setting:** To use this function, install a rotor and close the door cover, otherwise the expected effect cannot be achieved! Press the **PRE-COOLING** key on the control panel.

The pre-cooling confirmation interface appears on the screen. Click Yes to activate the pre-cooling function. The pre-cooling process and the pre-cooling finish displays are as follows:



The fixed temperature is 0.0 °C. When the temperature drops from room temperature to 0.0 °C, the countdown runs for 3 minutes (keeping the temperature inside the centrifugal chamber in depth) and the status bar appears. Press the **START** key to end this function.

■ **Manual setting of rotor number:** This function is used when the automatic rotor recognition fails, and an alarm message appears showing the error code.

To deactivate the automatic rotor recognition function, enter the secondary menu interface. Ask your dealer for the password.

■ After the machine speed stabilizes, if necessary, the parameters such as speed/centrifugal force, time, acceleration/deceleration can be modified again.

■ **End prompt tone/tone key:** This device comes with four end and mute states for selection, and the sound key can also be manually turned on and off.

■ **Language selection:** This machine comes with Chinese and English interfaces for selection.

■ **Screen brightness setting:** The screen brightness can be adjusted on the second page of the menu interface; 0-100 adjustable.

■ **Timer Mode:** There are two timing modes, namely start timing and stable speed timing.

Menu function is shown in the following figure:

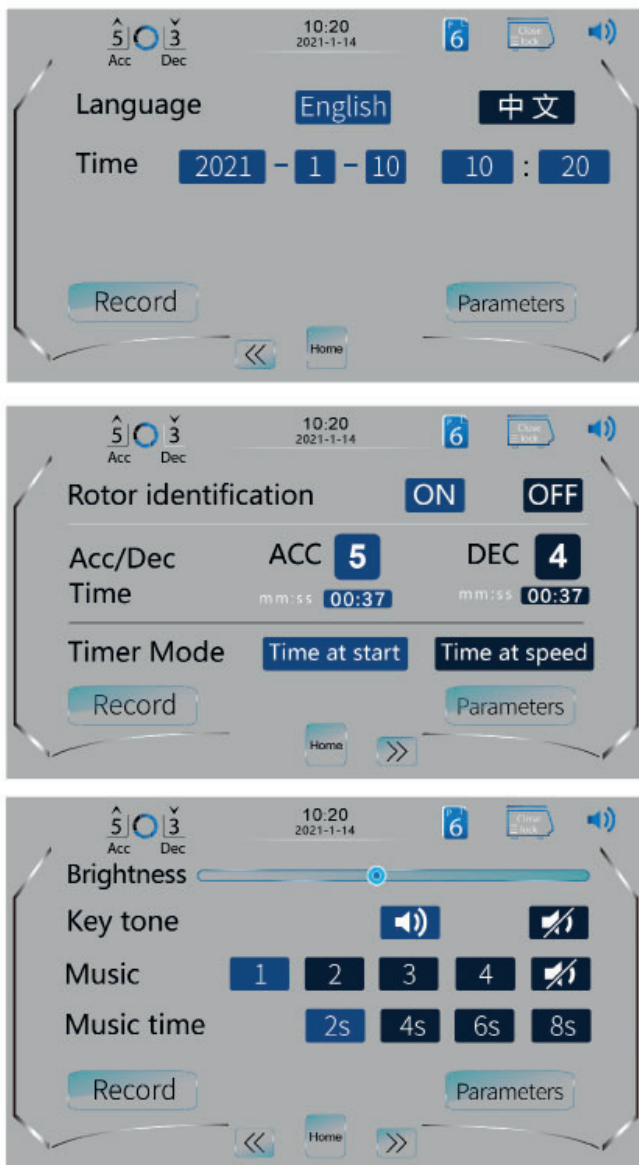

- Before setting parameters, the rotor must be correctly installed on the shaft.
- If an error is found during the parameter setting process, the parameters can be reset.

Figure 7: Menu function

5.11 Calculation of centrifugal force

The relative centrifugal force is generally thousands of times of Gravity of Earth (g). It is a unit used to measure the efficiency of centrifuges in separating objects. The calculation of centrifugal force is related to centrifugal speed and centrifugal radius, and is calculated according to the following equation:

$$RCF = 11.18 \times (n/1000)^2 \times r$$

r: Centrifugal radius, in cm

n: Centrifugal speed in rpm (revolutions per minute)

Note: The maximum centrifugal force value is related to the maximum centrifugal radius. The “centrifugal force value” set should take into account the radius of the rotor and the shape of the centrifugal container.

5.12 Running curve interface

Speed

Temperature

When the instrument is running, it can be observed in real-time through a digital interface or curve interface. The curve interface can display real-time curves through the **Speed** and **Temperature** icons, and the speed, timing, and temperature can be adjusted in real-time.

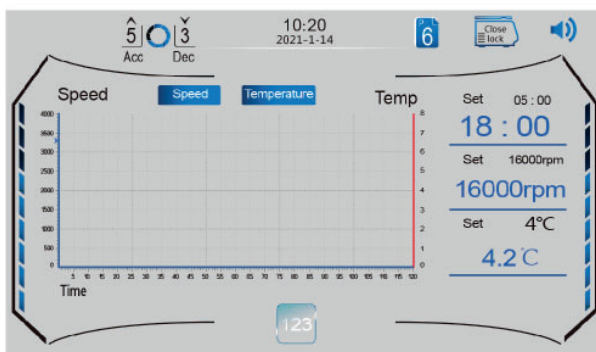
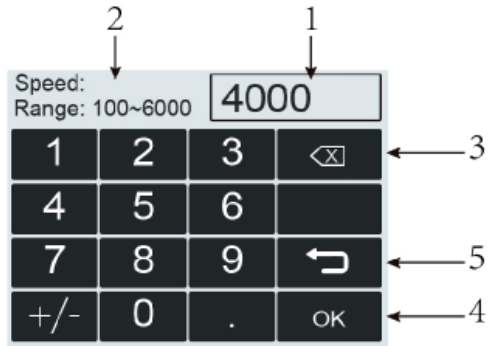

Figure 8: Schematic diagram of the operation curve interface

5.13 Main parameters setting interface



Speed setting interface

- 1: Set speed display
- 2: Speed setting range display
- 3: Delete key
- 4: OK/Confirm key
- 5: Return key

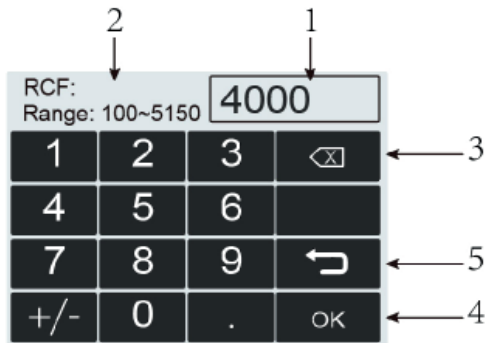

Relative centrifugal force setting interface

- 1: Set centrifugal force display
- 2: RCF setting range display
- 3: Delete key
- 4: OK/Confirm key
- 5: Return key

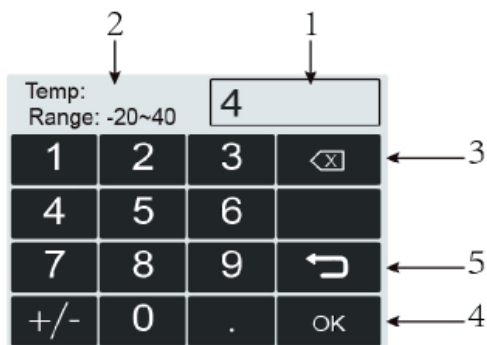

Temperature setting interface

- 1: Set temperature display
- 2: Temperature setting range display
- 3: Delete key
- 4: OK/Confirm key
- 5: Return key

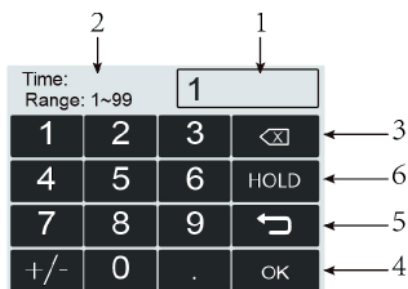

Hour setting interface

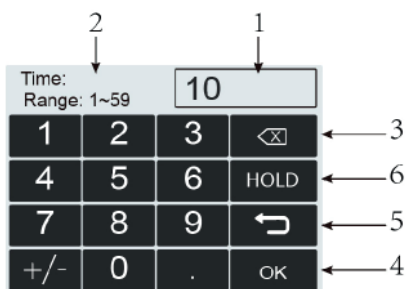

Minute setting interface

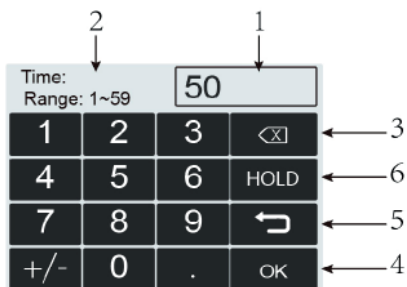

Seconds setting interface

Time setting interface

- 1: Set time display
- 2: Time setting range display
- 3: Delete key
- 4: OK/Confirm key
- 5: Return key
- 6: HOLD continuous mode

6. MAINTENANCE

6.1 Cleaning / Decontamination

Do not attempt to clean the centrifuge when the power cord is plugged in or the power switch is turned on. If the equipment or accessories are contaminated by pathogenic, toxic or radioactive materials, it is the responsibility of the user to perform proper cleaning/decontamination. The selected cleaning/decontamination method could damage the equipment; consult with your supplier first. If you plan to send equipment or accessories to the Technical Service for repair, you must ensure that are clean and harmless to the human body.

Do not use organic solvents because it can decompose the grease in the motor bearings; during the cleaning process, liquids, especially organic solvents, cannot be contacted to the motor shaft and the bearings.

Regular cleaning and maintenance work should include centrifuge shell, inner chamber and rotor. This is to prevent pollutants from being left on the surfaces, causing corrosion and environmental pollution.

6.2 Maintenance

Basic maintenance to be carried out by the user of the centrifuge:

- Check that the rotor body and its components are in good condition. If you notice any damage, for safety reasons, do not continue working with them and consult the Technical Service.
- Grease the swing out rotor brackets and check that the tube holders swing freely.
- Check rubber parts.
- Clean the centrifuge inside and out with non-abrasive products.
- Check the power cable. If any damage is found, replace it immediately.
- Ensure that ventilation openings are not obstructed and allow normal airflow.
- Do not use sharp objects to collide with the rotor. Prevent bumps during handling and disassembly. Prevent cracks in the rotor during use due to scratches or trauma.
- Regularly check the rotor assembly for corrosion spots, grooves, and small cracks. If any of the above conditions are found, stop using the rotor and contact the Technical Service.



When disassembling the rotor, grab it with both hands and lift it vertically, do not shake it from side to side!

- Normally, the rotor should be cleaned once a week. If it is used for salt solutions or other corrosive samples, please wash it immediately after use. If the sample is found to be spilled on the rotor, it should be immediately drained and partially cleaned.
- When cleaning the rotor, clean it with a mild detergent dampened with a sponge or cotton cloth, then wash off the detergent with distilled water. Do not sprinkle or spray the rotor with water as the liquid may be left somewhere and cause corrosion. Allow to invert and dry after washing.
- Use rags or tweezers to remove the dirty debris in the centrifuge chamber.
- The connecting parts of motor shaft and rotor shaft hole shall be coated with lubricating oil.
- Steps for motor shaft maintenance:
 - Turn on the power switch and wait until the self-inspection is completed; press the key to open the centrifuge door cover.
 - Use the supplied special tool for disassembling and assembling the rotor, unscrew the locking nut and take out the rotor. Note: the clockwise direction is to tighten the locking nut, and the counterclockwise direction is to loosen the locking nut.
 - Clean the taper surface of the motor shaft, and do not leave dirt. Add proper amount of lubricating

oil or use lubricating paper to coat it.

■ When disassembling and assembling the machine, the power must be cut off first, and the power cord connected to the back wall of the machine must be unplugged. Live operation is not allowed to prevent the personnel from getting electric shock or damaging the machine. Note: This operation can only be carried out by specially trained maintenance personnel.

■ Only use spare parts supplied by the manufacturer.

■ The power supply shall be cut off when the centrifuge is not in use.

■ Transportation and storage

This machine is a precision device. During transportation and storage, please pay attention to moisture-proof and shockproof. Do not place it horizontally or upside down.

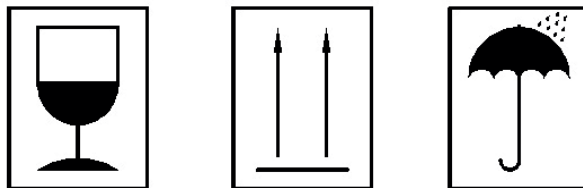

Figure 9: Precautions for transportation and storage

7. FAULT TREATMENT

7.1 Opening the door in emergency

During normal use, due to accidental power failure or door opening failure, you cannot use the automatic door opening function. In this case, you can use the centrifuge's manual door opening method to open the door cover and take out the samples. Note: This method is only allowed to be used in an emergency and must not be used casually.



When there is a power outage, the rotor stops running without braking function, and it takes a long time to stop completely. Please be patient!

Emergency door opening steps are as follows:

■ Confirm that the rotor stops completely.

■ Turn off the power switch.

■ Use the supplied tool, insert it into the emergency door opening and turn it clockwise until the door cover is opened; then you can take out the samples.

7.2 Fault alarm information

The following list shows the alarm information indicated by the centrifuge, the causes of related faults and solution methods, so you can eliminate the faults according to the prompts. If the user is still unable to eliminate the fault after trying or the indicated alarm information is not in the following list, the user should immediately contact the Technical Service.



After an abnormality occurs, the power should be turned off first and restarted after the fault is resolved.

Table 3: Fault alarm information

| Fault code | Meaning | Troubleshooting |
|-----------------|-------------------------------|--|
| Error 01 | Imbalance | <ol style="list-style-type: none"> 1. Place the samples in balance, with an allowable imbalance of $\leq 1.5\text{g}$. 2. Check whether the two ends of the output line of the imbalance protection switch are short circuited and closed (under normal circumstances, it should be in an open circuit state). 3. Contact the dealer to replace accessories. |
| Error 02 | Speeding | When it is detected during operation that the speed exceeds the maximum rotor speed by 600 rpm; it usually occurs in the rising stage and the speed up gear should be reduced. |
| Error 03 | Door cover not closed | <ol style="list-style-type: none"> 1. Check if the door cover signal wiring is properly plugged in. 2. Check if there is an open circuit at both ends of the lead wire of the door cover detection switch (it should be in a short circuit closed state under normal door cover closure). |
| Error 04 | Hall sensor fault | Motor Hall sensor fault, check if the motor Hall sensor wire is properly connected or if the Hall sensor is damaged. |
| Error 05 | Brake over-pressure | <ol style="list-style-type: none"> 1. Check if the brake resistor is properly connected or if the brake resistor is burnt out. 2. Reduce the DEC value. |
| Error 06 | Overcurrent | <ol style="list-style-type: none"> 1. Accelerate too quickly under heavy load, reduce the ACC value. 2. Drive board failure or high external power supply voltage. 3. Motor failure. |
| Error 07 | No speed measurement | <ol style="list-style-type: none"> 1. Check the speed measuring cable to ensure that it is connected properly. 2. The motor speed measuring Hall sensor is faulty, and the speed measuring plate at the end of the motor needs to be replaced. |
| Error 08 | Communication error | <ol style="list-style-type: none"> 1. Check if the communication cable (10 pins grey flat cable) is connected properly. 2. The drive board is faulty and needs to be replaced. |
| Error 09 | Overvoltage | Ensure that the voltage supply of the external power grid meets the rated voltage of the machine. |
| Error 10 | Temperature measurement fault | <ol style="list-style-type: none"> 1. Check if the sensor plug is connected properly. 2. Sensor open circuit, contact the dealer. |
| Error 11 | Speed not reached | Contact the dealer. |

| Fault code | Meaning | Troubleshooting |
|-----------------|-------------------------------------|---|
| Error 12 | Rotor identification fault | The rotor is not installed in place. |
| Error 13 | Missing rotor identification signal | <ol style="list-style-type: none"> 1. The rotor is not installed in place. 2. The magnetic steel at the bottom of the rotor falls off. |
| Error 14 | Rotor mismatch | Check if the set rotor is consistent with the actual rotor. |
| Error 15 | The rotor cannot be identified | <ol style="list-style-type: none"> 1. Check if the sensor plug is connected properly. 2. Sensor open circuit, contact the dealer. |
| Error 16 | Wrong rotor setting | Check if the set rotor is consistent with the actual rotor. |
| Error 17 | Drive overtemperature protection | Drive board module temperature too high. |
| Error 18 | Low voltage | The input voltage of the mains power supply is too low. |
| Error 19 | Record export failed | USB drive export history failed <ol style="list-style-type: none"> 1. USB drive not connected or not inserted properly 2. USB drive not formatted as required 3. Loose USB drive connection cable |
| Error 20 | Unlock timeout | When the unlocking action exceeds the set time, the fully opened position is still not detected. |
| Error 21 | Lock timeout | The locking action exceeded the set time and still did not detect the fully closed position. |
| Error 22 | Switch limit error | Simultaneously detecting switch limit. |

Table 4: Failures, causes and troubleshooting

| Failure | Failure causes and troubleshooting |
|---|---|
| Display off or suddenly the display turns off | <ol style="list-style-type: none"> 1. Check whether the power socket and the connection are good, and whether the power socket is charged. 2. Check whether the power switch has no good contact. 3. Check the fuse. If it is blown, please replace the fuse. 4. If the cause cannot be found, please contact the Technical Service. |
| The machine is suddenly stopped in operation | <ol style="list-style-type: none"> 1. The speed is over the maximum rated speed of the rotor. 2. Once the rotor exceeds the max. rated speed of the rotor by more than 600 rpm, the overspeed alarm will work immediately. At this time, the speed must be reset after the shutdown. 3. The speed is over the set speed. 4. When the motor is overheated, the power is cut off inside the machine and the machine stops running. 5. If the keyboard panel does not work, please check the power supply system of the machine. 6. The voltage may be too low; check whether the power supply voltage meets the requirements. |
| The door can't be opened | <ol style="list-style-type: none"> 1. Rotor has not stopped completely; the door should not be opened. 2. Check the door lock components. 3. Check the electrical wiring of the door lock. 4. Open the door by manual method. 5. If the cause cannot be found, please contact the Technical Service. |
| The machine vibrates greatly | <ol style="list-style-type: none"> 1. The rotor over the critical speed, some machine vibration is normal. 2. Check whether the rotor is locked. 3. Check the symmetry of the rotor load and check the level of the machine. 4. Check whether the rotor is properly installed. 5. Check the drive shaft and rotate by hand. If it cannot rotate smoothly, there may be a problem with the drive shaft or motor. |
| The display shows an exception | <p>May be caused by the power grid interference, please shut down, to stop for one minute before the boot; the display can be normal again.</p> |
| The motor does not rotate after pressing the start key | <p>The electrical control circuit is broken, replace the electrical control board.</p> |
| The machine smells burnt | <ol style="list-style-type: none"> 1. Cut off the power supply. 2. Check whether the motor is burned down. 3. Check whether the electrical components are burned down. |

8. TECHNICAL DATA

| Function / Parameter | Technical data |
|--|--|
| Operating environment | <ul style="list-style-type: none"> - Indoor use only - There is no vibration and airflow affecting the centrifuge performance. There is no conductive dust, explosive gas and corrosive gas in the surrounding air. - Altitude: ≤ 2000 m - Relative humidity: ≤ 80 % - Ambient temperature: $+5^{\circ}\text{C} - 40^{\circ}\text{C}$ |
| Power supply | 220VAC $\pm 10\%$, 50/60Hz |
| Protection system | Electronic short-circuit overload protector |
| Set time range | 1-99 hours/1-59 minutes/1-59 seconds. Three modes are available for selection. Accuracy ± 1 second. |
| Max. speed | 6000 rpm ± 20 rpm The rated maximum speed of different rotors is different. Below the rated maximum speed, the speed can be set arbitrarily. |
| Max. RCF | 5150 $\times g$ |
| Max. capacity | 1000 mL (250 mL $\times 4$) |
| Acceleration | Speed up time from zero to maximum speed ≤ 30 seconds |
| Deceleration | Time to decelerate from maximum speed to zero ≤ 25 seconds |
| Temperature range | $-20^{\circ}\text{C} - +40^{\circ}\text{C}$ /Step increase of 0.1°C /display accuracy of 0.1°C /control accuracy of $\pm 2^{\circ}\text{C}$ |
| Display screen | Touch screen, 7-inch IPS color LCD display, resolution 1024 \times 600 dpi |
| Cooling effect and temperature stability accuracy | <p>When the temperature of the centrifugal chamber is consistent with the ambient temperature, the cooling time of the centrifugal chamber to reach 0°C shall not exceed 15 minutes.</p> <p>At maximum load/maximum speed the lowest temperature to which the centrifugal chamber can be cooled is 0°C.</p> <p>The accuracy of the temperature inside the centrifugal chamber shall not exceed $\pm 2^{\circ}\text{C}$.</p> |
| Noise (at max. speed) | ≤ 65 dB(A) |
| Size | 700 mm (L) \times 620 mm (W) \times 380 mm (H) |
| Weight (without rotor) | 95 Kg |
| Interference suppression standards | EN 61010-1, EN 61010-2-020, EN 61326-1, EN 61010-3-2/A2 |

9. PACKING LIST

| No. | Name | Quantity | Notes |
|-----|------------------------|----------|------------------------|
| 1 | 2761R model centrifuge | 1 | |
| 2 | Power cord | 1 | |
| 3 | Rotor | 1 | According to the order |
| 4 | Special hexagonal key | 1 | |
| 5 | Lubricating grease | 1 | |
| 6 | User Manual | 1 | |

10. WARRANTY

AUXILAB S.L. guarantees this centrifuge against manufacturing defects for a period of 24 months from the date of purchase, under the following assumptions:

- It covers any manufacturing defect, including the labour necessary to locate and change the defective parts at AUXILAB S.L. Technical Service.
- This warranty DOES NOT COVER breakdowns which, in the opinion of AUXILAB S.L. Technical Service, have been caused by incorrect installation, incorrect treatment, improper use or manipulation by personnel outside AUXILAB S.L. Technical Service.
- Spare parts with a limited life, such as fuses, batteries, etc., are not covered by the guarantee.
- Any device whose serial number has been removed or altered is considered out of warranty.
- It is expressly excluded any recognition of direct or indirect damages of any kind suffered by persons or things.