

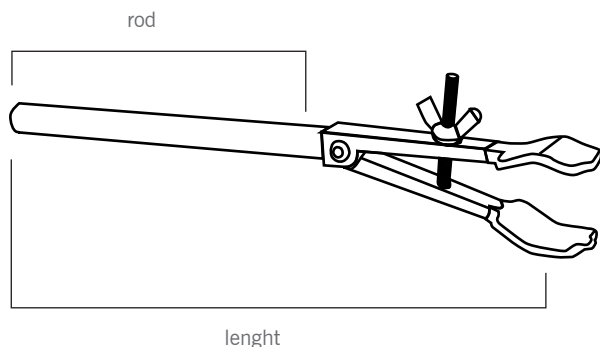

Laboratory clamps are a wide variety of products used for holding beakers, burettes, thermometers, condensers, etc., in laboratory assemblies, or for an easy and safe handling of recipients that have been heated at high

temperatures or that contain dangerous reagents such as assay tubes, crucibles, evaporating dishes or beakers. Please take a look of our wide offer of laboratory clamps to find the model that best suits your necessities.

Clamp dimensions without bosshead



Clamp dimensions with bosshead

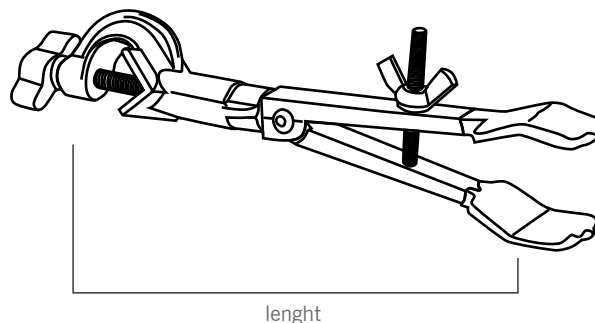

▶ Automatic clamps



CODE:FCG009



CODE:FCG010

Made of chrome-plated metal, they are especially suited for holding burettes and thermometers. With a spring shutter to hold diameters up to 25 mm. The model with bosshead is provided with a rotary bosshead for rods up to 18 mm diameter.

Code	Opening	Length	Bosshead	Rod (ØxL)
FCG010	0-25 mm	160 mm	No	8x120 mm
FCG009	0-25 mm	110 mm	Rotary	--

▶ Clamps with 4 prongs



CODE:FCJ012



CODE:FCJ013



CODE:FCJ014



CODE:FCJ015

Made of chromeplated metal, they present the prongs with cork protectors to avoid damages. Opening of 0-80 mm. The model with bosshead is provided with a rotary bosshead for rods up to 18 mm diameter.

Code	Length	Bosshead	Rod (ØxL)	Opening
FCJ012	230 mm	No	8x155 mm	0-80 mm
FCJ015	160 mm	Rotary	--	0-80 mm
FCJ013	250 mm	No	10x130 mm*	0-80 mm
FCJ014	230 mm	No	12x145 mm (Double adjustment)	0-80 mm
FCJ016	-	No	10x165 mm	0-100 mm
FCJ017	-	No	12x165 mm	0-100 mm

*adjustable angle 180°



▶ Clamps with 3 prongs

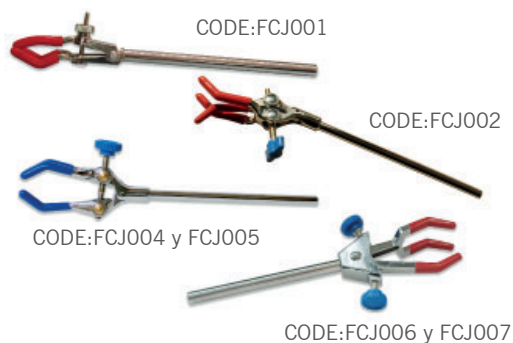

Made of chrome-plated metal with PVC coated prongs. They are available models with a single adjustment or with double independent adjustment.

Without bosshead

Code	Opening	Length	Adjustment	Rod (ØxL)
FCJ001	0-30 mm	175 mm	Single	8x125 mm
FCJ002	0-70 mm	240 mm	Single (blue)	8x150mm
FCJ003	0-70 mm	240 mm	Single (red)	8x150 mm
FCJ004	0-95 mm	240 mm	Single, blue	12x180 mm
FCJ005	0-95 mm	240 mm	Single, blue	8x150 mm
FCJ006	0-50 mm	210 mm	Double	10x140 mm
FCJ007	0-85 mm	250 mm	Double	12x155 mm

With bosshead

With rotary bosshead for rods up to 18 mm diameter.

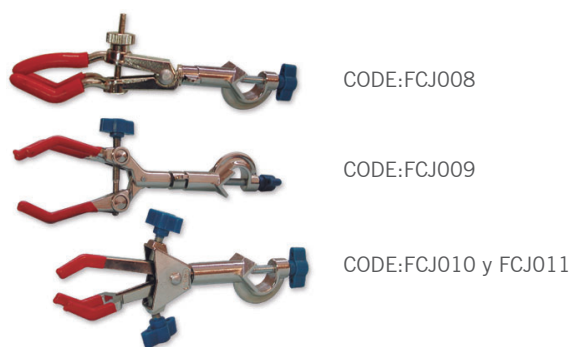

Code	Opening	Length	Adjustment
FCJ008	0-30 mm	125 mm	Single
FCJ009	0-70 mm	165 mm	Single
FCJ010	0-60 mm	145 mm	Double
FCJ011	0-90 mm	170 mm	Double

▶ Double clamps for burettes

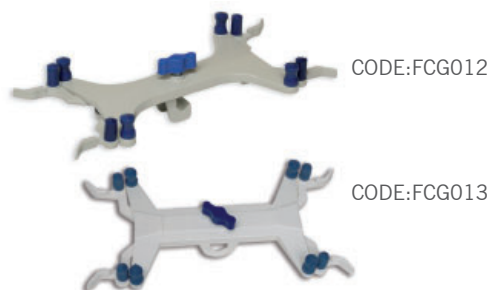

Automatic clamp for holding two burettes at the same time. They allow the visualization of the graduation all along the scale of the burette. With bosshead for rods up to 13 mm diameter and rubber covered prongs.

Code	Material	Colour	Rods	Prongs
FCG012	Aluminium	White	Up to 13 mm	Rubber
FCG013	Plastic	White	Up to 13 mm	Rubber

▶ Single clamp for burettes



Code	Capacity	Rods
FCG015	1 burettes	From 10 to 12 mm
FCG014	2 burettes	From 10 to 12 mm



▶ Clamps with 2 prongs

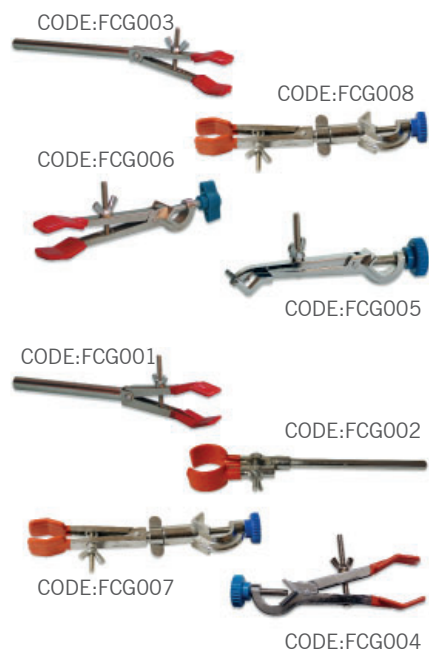

For burettes and tubes

Made of chromeplated metal with PVC-covered prongs (except cod FCG005)

Code	Opening	Length	Bosshead
FCG003	7-25 mm	205 mm	No (rod of 10x130 mm)
FCG008	7-25 mm	150 mm	Rotary, up to 18 mm Ø
FCG006	7-25 mm	100 mm	Fixed, up to 14 mm Ø
FCG005	4-20 mm	100 mm	Fixed, up to 14 mm Ø

For burettes and condensers

Made of chrome-plated metal with PVC-covered prongs.

Code	Opening	Length	Bosshead
FCG001	12-45 mm	210 mm	No (rod of 10x130 mm)
FCG002	20-60 mm	220 mm	No (rod of 10x140 mm)
FCG007	12-45 mm	155 mm	Rotary, up to 18 mm Ø
FCG004	12-45 mm	110 mm	Fixed, up to 17 mm Ø

▶ Clamp for big diameters



Made of stainless steel with chain and spring clamp, it allows holding securely recipients with big diameters.

Code	For diameters
FCK003	90-145 mm

▶ Clamp for thermometers



Made of chrome-plated metal with rotary bosshead for rods up to 18 mm diameter.

Code	Opening	Length
FCK001	6-15 mm	140 mm

▶ Suspension clamp for thermometers



Made of chrome-plated metal and with fixed bosshead for rods up to 18 mm diameter. It allows hanging a thermometer over a recipient with the liquid whose temperature must be controlled.

Code	Length
FCK002	130 mm



▶ Test tube clamps



They allow holding and safety transporting test tubes heated at high temperatures. For tubes up to 25 mm diameter.

Code	Length	Material
FFN005	150 mm	Steel
FFN006	180 mm	Wooden

▶ Beaker tongs

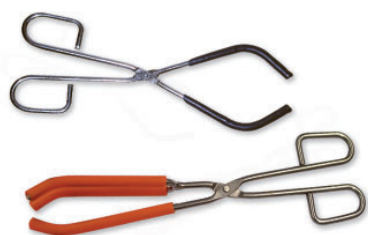

To hold and safely transport beakers at high temperatures or with dangerous substances. Made of chrome-plated steel, they present PVC-coated prongs to avoid the beaker slips.

Code	Model	Opening	Length
FFN001	2 dedos	50-150 mm	275 mm
FFN002	3 dedos	0-160 mm	250 mm
FFN003	3 dedos	0-220 mm	300 mm

▶ Evaporating dish tong



Especially suited for holding and transporting porcelain evaporating dishes or any other flan-bottom recipient (Petri dishes, crystallizing dishes,..) that have been heated at high temperatures thus making easier its extraction from ovens or furnaces. Made of stainless steel.

Code	Length	Opening
FFL012	260 mm	65-190 mm

▶ Crucible tongs



Made of stainless steel or chromeplated steel. With bow and curved serrated jaws.

Code	Total length	Opening	Material
FFL001	150 mm	20 mm	Chromeplated steel
FFL002	200 mm	28 mm	Chromeplated steel
FFL003	250 mm	32 mm	Chromeplated steel
FFL004	300 mm	32 mm	Chromeplated steel
FFL005	350 mm	32 mm	Chromeplated steel
FFL006	400 mm	40 mm	Chromeplated steel
FFL007	450 mm	40 mm	Chromeplated steel
FFL009	200 mm	25 mm	Stainless steel
FFL010	250 mm	28 mm	Stainless steel
FFL011	300 mm	32 mm	Stainless steel



▶ Hoffman clamps



Made of nickelplated steel they present a compressor screw and a base with two positions (open or close). To compress latex tubes and thus adjust the gas or liquid flow.

Code	Opening
FHD001	12 mm
FHD002	17 mm
FHD003	20 mm
FHD004	25 mm
FHD005	30 mm
FHD006	40 mm

▶ Mohr clamps



CODE:FHD012



Made of nickel-plated metal. To compress latex tubes and thus regulated the liquid or gas flow.

Code	Length
FHD007	40 mm
FHD012	45 mm
FHD008	50 mm
FHD009	60 mm
FHD010	70 mm
FHD011	80 mm

CODE:FHD007 to FHD011

▶ Spherical joint clamps



Made of stainless steel, they are used for holding spherical ground joints. With locking screw for maximum security.

Code	Joint diameter
FCM019	13 mm
FCM020	19 mm
FCM021	29 mm
FCM022	35 mm

▶ Clips for tapered ground joints



Chromium-plated steel

Code	Ground joint
FCM001	10/19
FCM002	14/23
FCM003	19/26
FCM004	24/29
FCM005	29/32
FCM006	45/40

Polyoxymethylene (POM)

Code	Ground joint	Colour
FCM007	14/23	Yellow
FCM008	19/26	Blue
FCM011	24/29	Green
FCM010	29/32	Red
FCM009	45/40	Brown

